

# B6

## 6" Universal Non-IC Housing

LAMP WATTAGE: (1) MAX. 150W R40/PAR38, 120W BR40, 85W BR30, 150W A21

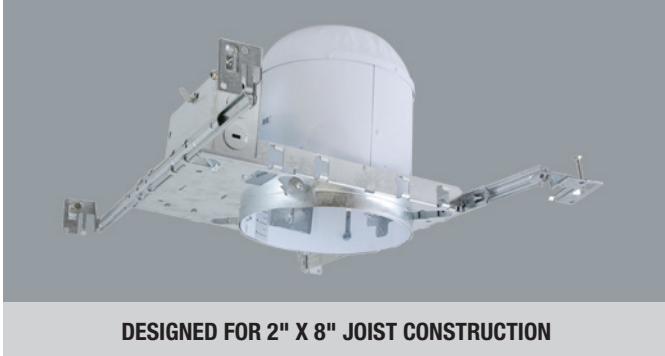

DESIGNED FOR 2" X 8" JOIST CONSTRUCTION

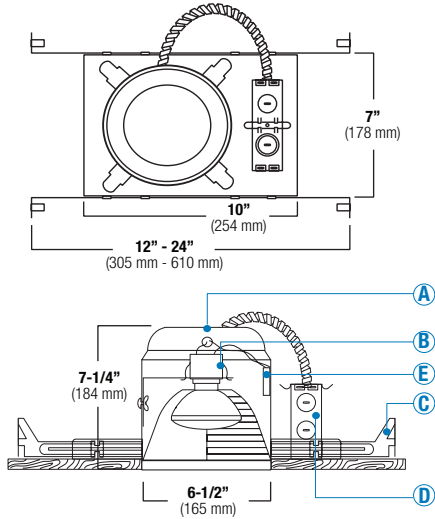

Catalog Number:

Project Name:

Type:

Note:



### DESCRIPTION

Thermally protected, specification grade recessed housing. For new construction non-insulated ceilings or where insulation can be kept 3" from housing. Accommodates up to 150W R40/PAR38, 120W BR40, 85W BR30 and 150W A21 lamps. Furnished with preinstalled adjustable bar hangers. Junction box is provided with four 1/2" KOs, one 3/4" KO and four Romex knockouts with strain relief.

### SPECIFICATION

**A. HOUSING** - High temperature painted 22 gauge cold rolled steel construction for maximum heat dissipation and rust protection. Adjusts vertically in plaster frame to accommodate 1/2" to 1-3/8" ceiling. Accommodate lamps up to 150W depending on trim used.

**B. SOCKET** - Medium base screw shell porcelain socket preinstalled on adjustable mounting bracket is designed to allow usage of different lamp types, as well as proper and consistent lamp positioning.

**C. BAR HANGERS** - Preinstalled bar hangers allow housing to be positioned and locked at any point within a 24" joist span. They can be positioned on either the long or short axis of the housing and can be shortened for 12" joists. They contain a double-headed real nail for 20° downward angle for better contact, and the 90° pivoting mounting plate makes installation fast and accurate. Bar hangers can fit onto T-Bar spline with additional slots and holes for special mounting methods if necessary.

**D. JUNCTION BOX** - UL listed for through-branch circuit wiring and has four 1/2" KOs, one 3/4" KO and four Romex knockouts with true pry-out slots and strain clamps.

**E. THERMAL PROTECTION** - Standard thermal protection device guards against improper installation, overlampping and misuse of insulation material.

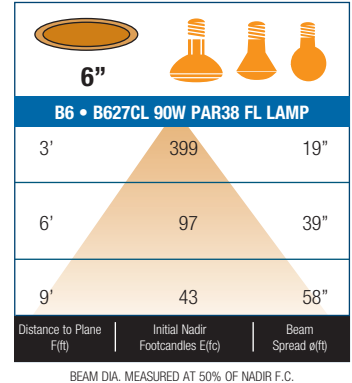

### FEATURES

- Thermally Protected Non-IC housing.
- Adjustable socket bracket.
- Wire through junction box.
- Preinstalled adjustable bar hanger.
- Dependable, favorable design and effortless installation.
- 7-1/4" height allows use in 2" x 8" joist construction.
- Special screw on the frame locks bar hangers in place which prevents the housing from any movement once installed.
- Preinstalled socket cap provides electrical contact protection against dust, paint and over spray.

### OPTIONS

#### AIR-SHUT

- Gasket to prevent air flow from heated or air conditioned spaces.
- Meets all national air flow requirements.

#### UL AND C-UL LISTED

- For Damp location
- For Feed-through wiring

ITEM SELECTOR: (Please check the boxes below for the option desired)

TYPE	AIR-SHUT	OPTION	TRIM TYPE	BAFFLE	REFLECTOR	TRIM/RING	GLASS
<b>B6</b>	<input type="checkbox"/> AT	<input type="checkbox"/> (W) With quick connects	<input type="checkbox"/> B630 <input type="checkbox"/> B609 <input type="checkbox"/> B605 <input type="checkbox"/> B658 <input type="checkbox"/> B634 <input type="checkbox"/> B625 <input type="checkbox"/> B640 <input type="checkbox"/> B619 <input type="checkbox"/> B605L <input type="checkbox"/> B659 <input type="checkbox"/> B649 <input type="checkbox"/> B624 <input type="checkbox"/> B620 <input type="checkbox"/> B646 <input type="checkbox"/> B606 <input type="checkbox"/> B675 <input type="checkbox"/> AF633 <input type="checkbox"/> B681 <input type="checkbox"/> B631 <input type="checkbox"/> B616 <input type="checkbox"/> B606L <input type="checkbox"/> B676 <input type="checkbox"/> B225 <input type="checkbox"/> B687 <input type="checkbox"/> B632 <input type="checkbox"/> B663 <input type="checkbox"/> B635 <input type="checkbox"/> B612 <input type="checkbox"/> B653 <input type="checkbox"/> B682 <input type="checkbox"/> AF640 <input type="checkbox"/> B664 <input type="checkbox"/> B636 <input type="checkbox"/> B645 <input type="checkbox"/> B651 <input type="checkbox"/> B693 <input type="checkbox"/> AF632 <input type="checkbox"/> B673 <input type="checkbox"/> B642 <input type="checkbox"/> B648 <input type="checkbox"/> B611 <input type="checkbox"/> B694 <input type="checkbox"/> B610 <input type="checkbox"/> B674 <input type="checkbox"/> B641 <input type="checkbox"/> B652 <input type="checkbox"/> B647 <input type="checkbox"/> B688 <input type="checkbox"/> B607 <input type="checkbox"/> B683 <input type="checkbox"/> B656 <input type="checkbox"/> B603 <input type="checkbox"/> B644 <input type="checkbox"/> B685 <input type="checkbox"/> B627 <input type="checkbox"/> B684 <input type="checkbox"/> B657 <input type="checkbox"/> B604 <input type="checkbox"/> B650 <input type="checkbox"/> B696 <input type="checkbox"/> B608 <input type="checkbox"/> B601 <input type="checkbox"/> B637 <input type="checkbox"/> B615 <input type="checkbox"/> B622 <input type="checkbox"/> B689 <input type="checkbox"/> B602 <input type="checkbox"/> B601L <input type="checkbox"/> B643 <input type="checkbox"/> B633 <input type="checkbox"/> B623 <input type="checkbox"/> B680	<input type="checkbox"/> W <input type="checkbox"/> CL <input type="checkbox"/> WH <input type="checkbox"/> Green <input type="checkbox"/> P <input type="checkbox"/> RG <input type="checkbox"/> BK <input type="checkbox"/> Yellow <input type="checkbox"/> SN <input type="checkbox"/> W <input type="checkbox"/> SN <input type="checkbox"/> Pink <input type="checkbox"/> CP <input type="checkbox"/> MB <input type="checkbox"/> CP <input type="checkbox"/> Brown <input type="checkbox"/> BZ <input type="checkbox"/> BZ <input type="checkbox"/> CH <input type="checkbox"/> Navy Blue <input type="checkbox"/> CP <input type="checkbox"/> PB <input type="checkbox"/> Orange <input type="checkbox"/> SN <input type="checkbox"/> BZ <input type="checkbox"/> Blue <input type="checkbox"/> SHZ <input type="checkbox"/> White <input type="checkbox"/> Red			

### Specifications:

B6



BAFFLE	REFLECTOR	TRIM/RING
W White	CL Chrome	WH White
P Black	RG Gold	BK Black
SN Satin Nickel	W White	SN Satin Nickel
CP Copper	MB Black	CP Copper
BZ Bronze	BZ Bronze	CH Chrome
	CP Copper	PB Polish Brass
	SN Satin Nickel	BZ Bronze
	SHZ Satin Haze	

Sample of Catalog Number: B6-AT-W-B630-W-WH

\*For custom baffle, reflector, trim ring, glass color and lens options, please consult factory.



Submittal form is available @ [www.iuseelite.com](http://www.iuseelite.com)  
Tel: 323-888-1973 • Fax: 323-888-1977

Specifications and Dimensions subject to change without notice.

REV: ELITE LIGHTING-SPEC-06-29-2011

# 6" Incandescent Trims

(LAMP WATTAGE: (1) MAX. 150W R40/PAR38, 120W BR40, 85W BR30, 150W A21)





Catalog Number:

Project Name:

Type:

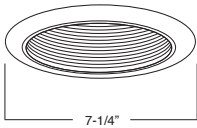
Note:

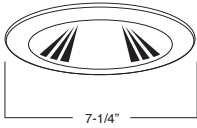

<p><b>B630CP-CP</b> METAL STEPPED BAFFLE R30/PAR30</p>  <p><b>BAFFLE FINISH:</b> W, P, SN, CP, BZ</p> <p><b>TRIM/RING FINISH:</b> WH, BK, SN, CP, CH, PB, BZ</p> 	<p><b>B640SN-SN</b> METAL STEPPED BAFFLE R40/PAR38</p>  <p><b>BAFFLE FINISH:</b> W, P, SN, CP, BZ</p> <p><b>TRIM/RING FINISH:</b> WH, BK, SN, CP, CH, PB, BZ</p> 	<p><b>B620-ORANGE</b> GLASS TRIM</p>  <p><b>GLASS FINISH:</b> GREEN, YELLOW, PINK, BROWN, NAVY BLUE, ORANGE, WHITE, RED</p> 	<p><b>B631P-WH</b> R30 PREMIUM PHENOLIC BAFFLE / METAL RING</p>  <p><b>BAFFLE FINISH:</b> W, P</p> <p><b>TRIM/RING FINISH:</b> WH, BK, SN, CP, CH, PB, BZ</p> 
<p><b>B632W-WH</b> R40 PREMIUM PHENOLIC BAFFLE / METAL RING</p>  <p><b>BAFFLE FINISH:</b> W, P</p> <p><b>TRIM/RING FINISH:</b> WH, BK, SN, CP, CH, PB, BZ</p> 	<p><b>AF640W-WH</b> DEEP SELF FLANGE AIR-SHUT BAFFLE</p>  <p><b>AVAILABLE COLOR COMBINATIONS:</b> W-WH, P-WH, SN-SN, CP-CP, BZ-BZ</p> <p><b>NEW CLIP DESIGN</b></p> 	<p><b>AF632RG-WH</b> AIR-SHUT REFLECTOR</p>  <p><b>AVAILABLE COLOR COMBINATIONS:</b> CL-WH, CL-CH, RG-WH, W-WH, MB-WH, CP-CP, SN-SN</p> <p><b>NEW CLIP DESIGN</b></p> 	<p><b>B610P-RG-WH</b> CONE REFLECTOR/BAFFLE TRIM</p>  <p><b>BAFFLE FINISH:</b> W, P</p> <p><b>REFLECTOR FINISH:</b> CL, RG</p> <p><b>TRIM/RING FINISH:</b> WH, BK, SN, CP, CH, PB, BZ</p> 
<p><b>B607CP-WH</b> REFLECTOR R/PAR30</p>  <p><b>REFLECTOR FINISH:</b> CL, RG, W, MB, CP, SN, BZ, SHZ</p> <p><b>TRIM/RING FINISH:</b> WH, BK, SN, CP, CH, PB, BZ</p> 	<p><b>B627RG-WH</b> REFLECTOR R40/PAR38</p>  <p><b>REFLECTOR FINISH:</b> CL, RG, W, MB, CP, SN, BZ, SHZ</p> <p><b>TRIM/RING FINISH:</b> WH, BK, SN, CP, CH, PB, BZ</p> <p><b>20W MAX</b></p> 	<p><b>B608CL-WH</b> CONE REFLECTOR A19</p>  <p><b>REFLECTOR FINISH:</b> CL, RG, W, MB, CP, SN, BZ, SHZ</p> <p><b>TRIM/RING FINISH:</b> WH, BK, SN, CP, CH, PB, BZ</p> 	<p><b>B602SN</b> EYEBALL</p>  <p><b>TRIM/RING FINISH:</b> WH, BK, SN, CP, CH, PB, BZ</p> 
<p><b>B609W-WH</b> REGRESSED EYEBALL WITH BAFFLE</p>  <p><b>BAFFLE FINISH:</b> W, P, SN, CP, BZ</p> <p><b>TRIM/RING FINISH:</b> WH, BK, SN, CP, CH, PB, BZ</p> <p><b>EYEBALL FINISH:</b> WH, BK, SN, CP, CH, PB, BZ</p> 	<p><b>B619RG-PB</b> REGRESSED EYEBALL WITH REFLECTOR</p>  <p><b>REFLECTOR FINISH:</b> CL, RG, W, MB, CP, SN</p> <p><b>TRIM/RING FINISH:</b> WH, BK, SN, CP, CH, PB, BZ</p> <p><b>EYEBALL FINISH:</b> WH, BK, SN, CP, CH, PB, BZ</p> 	<p><b>B646P-WH</b> EYEBALL WITH BAFFLE</p>  <p><b>BAFFLE FINISH:</b> W, P</p> <p><b>TRIM/RING FINISH:</b> WH</p> 	<p><b>B616W-WH</b> PAR20 REGRESSED EYEBALL W/ BAFFLE</p>  <p><b>BAFFLE FINISH:</b> W, P, SN, CP, BZ</p> <p><b>TRIM/RING FINISH:</b> WH, BK, SN, CP, CH, PB, BZ</p> <p><b>EYEBALL FINISH:</b> WH, BK, SN, CP, CH, PB, BZ</p> 

# 6" Incandescent Trims

(LAMP WATTAGE: (1) MAX. 150W R40/PAR38, 120W BR40, 85W BR30, 150W A21)

Catalog Number:	
Project Name:	Type:
Note:	



<p><b>B663PB</b> PAR30 GIMBAL RING</p>  <p><b>TRIM/RING FINISH:</b> WH, BK, SN, CP, CH, PB, BZ</p> 	<p><b>B664CP</b> PAR38 GIMBAL RING</p>  <p><b>TRIM/RING FINISH:</b> WH, BK, SN, CP, CH, PB, BZ</p> 	<p><b>B673P-WH</b> PAR30 BAFFLE W/ GIMBAL RING</p>  <p><b>BAFFLE FINISH:</b> W, P, SN, CP, BZ</p> <p><b>TRIM/RING FINISH:</b> WH, BK, SN, CP, CH, PB, BZ</p> 	<p><b>B674W-WH</b> PAR38 BAFFLE W/ GIMBAL RING</p>  <p><b>BAFFLE FINISH:</b> W, P, SN, CP, BZ</p> <p><b>TRIM/RING FINISH:</b> WH, BK, SN, CP, CH, PB, BZ</p> 
<p><b>B683CL-WH</b> PAR30 REFLECTOR W/ GIMBAL RING</p>  <p><b>REFLECTOR FINISH:</b> CL, RG, W, MB, CP, SN</p> <p><b>TRIM/RING FINISH:</b> WH, BK, SN, CP, CH, PB, BZ</p> 	<p><b>B684RG-WH</b> PAR38 REFLECTOR W/ GIMBAL RING</p>  <p><b>REFLECTOR FINISH:</b> CL, RG, W, MB, CP, SN</p> <p><b>TRIM/RING FINISH:</b> WH, BK, SN, CP, CH, PB, BZ</p> 	<p><b>B601CP</b> METAL ALBALITE LENS</p>  <p><b>LENS:</b> ALBALITE</p> <p><b>TRIM/RING FINISH:</b> WH, BK, SN, CP, CH, PB, BZ</p> 	<p><b>B601L</b> PLASTIC ALBALITE LENS</p>  <p><b>LENS:</b> ALBALITE</p> <p><b>TRIM/RING FINISH:</b> WHITE PLASTIC</p> 
<p><b>B605PB</b> METAL FRESNEL LENS</p>  <p><b>LENS:</b> FRESNEL</p> <p><b>TRIM/RING FINISH:</b> WH, BK, SN, CP, CH, PB, BZ</p> 	<p><b>B605L</b> PLASTIC FRESNEL LENS</p>  <p><b>LENS:</b> FRESNEL</p> <p><b>TRIM/RING FINISH:</b> WHITE PLASTIC</p> 	<p><b>B606CP</b> METAL DROP OPAL LENS</p>  <p><b>LENS:</b> DROP OPAL</p> <p><b>TRIM/RING FINISH:</b> WH, BK, SN, CP, CH, PB, BZ</p> 	<p><b>B606L</b> PLASTIC DROP OPAL LENS</p>  <p><b>LENS:</b> DROP OPAL</p> <p><b>TRIM/RING FINISH:</b> WHITE PLASTIC</p> 
<p><b>B635P-WH</b> BAFFLE W/ ALBALITE LENS</p>  <p><b>BAFFLE FINISH:</b> W, P, SN, CP, BZ</p> <p><b>TRIM/RING FINISH:</b> WH, BK, SN, CP, CH, PB, BZ</p> 	<p><b>B636W-WH</b> BAFFLE W/ FRESNEL LENS</p>  <p><b>BAFFLE FINISH:</b> W, P, SN, CP, BZ</p> <p><b>TRIM/RING FINISH:</b> WH, BK, SN, CP, CH, PB, BZ</p> 	<p><b>B641RG-WH</b> REFLECTOR W/ ALBALITE LENS</p>  <p><b>REFLECTOR FINISH:</b> CL, RG, W, MB, CP, SN, SHZ</p> <p><b>TRIM/RING FINISH:</b> WH, BK, SN, CP, CH, PB, BZ</p> 	<p><b>B642CL-WH</b> REFLECTOR W/ FRESNEL LENS</p>  <p><b>REFLECTOR FINISH:</b> CL, RG, W, MB, CP, SN, SHZ</p> <p><b>TRIM/RING FINISH:</b> WH, BK, SN, CP, CH, PB, BZ</p> 

# 6" Incandescent Trims

(LAMP WATTAGE: (1) MAX. 150W R40/PAR38, 120W BR40, 85W BR30, 150W A21)

Catalog Number:

Project Name:

Type:

Note:



**B656W-WH**  
BAFFLE W/ FROSTED DOME SHOWER LENS



**BAFFLE FINISH:**  
W, P, SN, CP, BZ

**TRIM/RING FINISH:**  
WH, BK, SN, CP, CH,  
PB, BZ

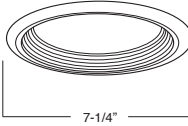

7-1/4"

**B657CL-WH**  
REFLECTOR W/ FROSTED DOME SHOWER LENS

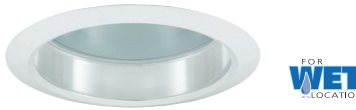

**REFLECTOR FINISH:**  
CL, RG, W, MB, CP,  
SN, SHZ

**TRIM/RING FINISH:**  
WH, BK, SN, CP, CH,  
PB, BZ

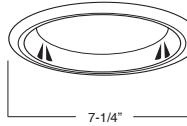

7-1/4"

**B637W-WH**  
BAFFLE W/ DROP OPAL LENS



**BAFFLE FINISH:**  
W, P, SN, CP, BZ

**TRIM/RING FINISH:**  
WH, BK, SN, CP, CH,  
PB, BZ

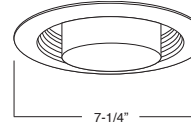

7-1/4"

**B643RG-WH**  
REFLECTOR W/ DROP OPAL LENS



**REFLECTOR FINISH:**  
CL, RG, W, MB, CP,  
SN, SHZ

**TRIM/RING FINISH:**  
WH, BK, SN, CP, CH,  
PB, BZ

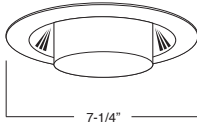

7-1/4"

**B658CL-WH**  
REFLECTOR W/ PRISMATIC LENS



**REFLECTOR FINISH:**  
CL, RG, W, MB, CP,  
SN, SHZ

**TRIM/RING FINISH:**  
WH, BK, SN, CP, CH,  
PB, BZ

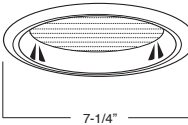

7-1/4"

**B659CL-WH**  
REFLECTOR W/ FROSTED LENS



**REFLECTOR FINISH:**  
CL, RG, W, MB, CP,  
SN, SHZ

**TRIM/RING FINISH:**  
WH, BK, SN, CP, CH,  
PB, BZ

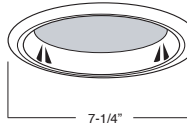

7-1/4"

**B675W-WH**  
BAFFLE W/ PRISMATIC LENS



**BAFFLE FINISH:**  
W, P, SN, CP, BZ

**TRIM/RING FINISH:**  
WH, BK, SN, CP, CH,  
PB, BZ

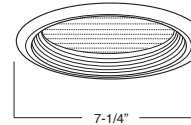

7-1/4"

**B676W-WH**  
BAFFLE W/ FROSTED LENS



**BAFFLE FINISH:**  
W, P, SN, CP, BZ

**TRIM/RING FINISH:**  
WH, BK, SN, CP, CH,  
PB, BZ

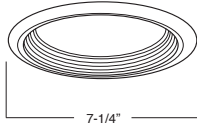

7-1/4"

**B612WH**  
SMOOTH FROST DOME SHOWER LENS



**LENS:**  
FROSTED

**TRIM/RING FINISH:**  
WH, BK, SN, CP, CH,  
PB, BZ

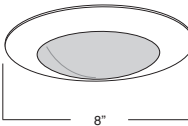

8"

**B645WH**  
DESIGNER POINT SHOWER LENS



**LENS:**  
FROSTED/CLEAR

**TRIM/RING FINISH:**  
WH, BK, SN, CP, CH,  
PB, BZ

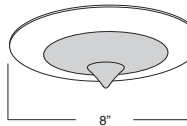

8"

**B648WH**  
DESIGNER CONE SHOWER LENS



**LENS:**  
FROSTED

**TRIM/RING FINISH:**  
WH, BK, SN, CP, CH,  
PB, BZ

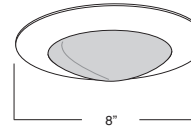

8"

**B652WH**  
SMOOTH FROST SHOWER LENS



**LENS:**  
FROSTED

**TRIM/RING FINISH:**  
WH, BK, SN, CP, CH,  
PB, BZ

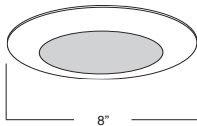

8"

**B603CP**  
R/PAR30 OPEN TRIM

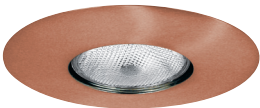

**TRIM/RING FINISH:**  
WH, BK, SN, CP, CH,  
PB, BZ

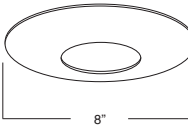

8"

**B604PB**  
R40/PAR38 OPEN TRIM



**TRIM/RING FINISH:**  
WH, BK, SN, CP, CH,  
PB, BZ

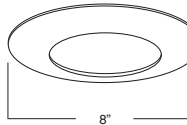

8"

**B615WH**  
DESIGNER PINHOLE



**TRIM/RING FINISH:**  
WH, BK

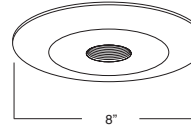

8"

**B633WH**  
R/PAR30 SPLAY TRIM



**TRIM/RING FINISH:**  
WH, BK

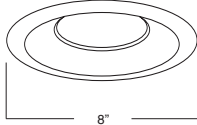

8"



# 6" Incandescent Trims

(LAMP WATTAGE: (1) MAX. 150W R40/PAR38, 120W BR40, 85W BR30, 150W A21)

Catalog Number:

Project Name:

Type:

Note:



**B634WH**  
R40/PAR38 SPLAY TRIM



**TRIM/RING FINISH:**  
WH, BK

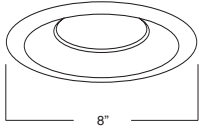

**B649RG-WH**  
PAR20 REFLECTOR



**REFLECTOR FINISH:**  
CL, RG, W, MB, CP, SN  
**TRIM/RING FINISH:**  
WH, BK

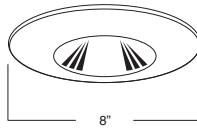

**AF633CH**  
R/PAR30 OPEN TRIM

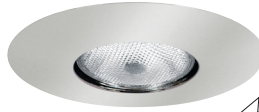

**TRIM/RING FINISH:**  
WH, BK, SN, CP, CH, PB, BZ

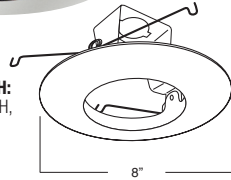

**B225WH**  
OPEN TRIM STEPPED BAFFLE



**BAFFLE FINISH:**  
W, P  
**TRIM/RING FINISH:**  
WH

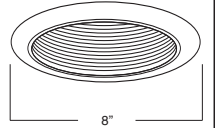

**B653W-WH**  
BAFFLE WITH BAFFLE

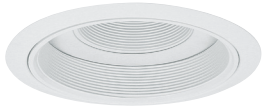

**BAFFLE FINISH:**  
W, P  
**TRIM/RING FINISH:**  
WH, BK, SN, CP, CH, PB

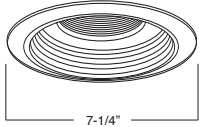

**B651P-WH**  
PAR20 STEPPED BAFFLE

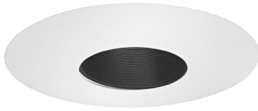

**BAFFLE FINISH:**  
W, P, SN, CP, BZ  
**TRIM/RING FINISH:**  
WH, BK

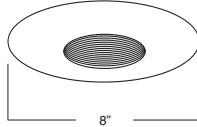

**B611W-WH**  
PAR30 BAFFLE WALL WASH

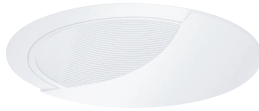

**AVAILABLE COLOR COMBINATIONS:**  
W-WH, P-WH, SN-SN, CP-CP, BZ-BZ  
**COVER FINISH:**  
WH, BK

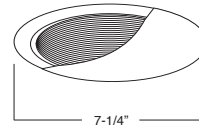

**B647P-WH**  
DESIGNER BAFFLE WALL WASH PAR20



**BAFFLE FINISH:**  
W, P, SN, CP, BZ  
**TRIM/RING FINISH:**  
WH

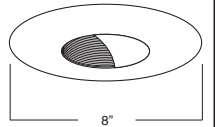

**B644RG-WH**  
DESIGNER REFLECTOR WALL WASH PAR20



**REFLECTOR FINISH:**  
CL, RG, W, MB, CP, SN  
**TRIM/RING FINISH:**  
WH

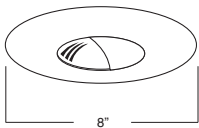

**B650WH**  
DESIGNER WALL WASH



**TRIM/RING FINISH:**  
WH

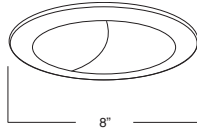

**B622RG-WH**  
R/PAR30 WALL WASH REFLECTOR



**REFLECTOR FINISH:**  
CL, RG, W, MB, CP, SN, SHZ  
**COVER FINISH:**  
WH  
**TRIM/RING FINISH:**  
WH, BK, SN, CP, CH, PB, BZ

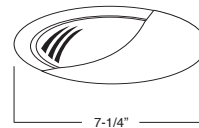

**B623MB-WH**  
R40/PAR38 WALL WASH REFLECTOR



**REFLECTOR FINISH:**  
CL, RG, W, MB, CP, SN, SHZ  
**COVER FINISH:**  
WH  
**TRIM/RING FINISH:**  
WH, BK, SN, CP, CH, PB, BZ

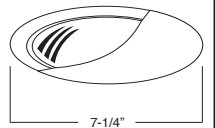

**B625CL-WH**  
A-19 CONE REFLECTOR WALL WASH



**REFLECTOR FINISH:**  
CL, RG, W, MB, CP, SN, SHZ  
**COVER FINISH:**  
WH  
**TRIM/RING FINISH:**  
WH, BK, SN, CP, CH, PB, BZ

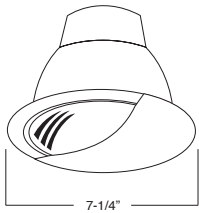

**B624W-CL**  
CONE REFLECTOR BAFFLE WALL WASH



**BAFFLE FINISH:**  
W, P  
**REFLECTOR FINISH:**  
CL, RG  
**COVER FINISH:**  
WH  
**TRIM/RING FINISH:**  
WH, BK, SN, CP, CH, PB, BZ

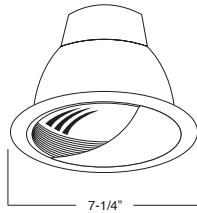

**B681CP-WH**  
SQUARE BAFFLE TRIM



**BAFFLE FINISH:**  
W, P, SN, CP, BZ  
**TRIM/RING FINISH:**  
WH, BK, SN, CP

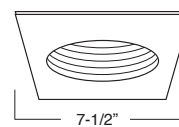

**B687CP-WH**  
SQUARE REFLECTOR TRIM

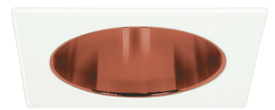

**REFLECTOR FINISH:**  
CL, RG, W, MB, SN, CP  
**TRIM/RING FINISH:**  
WH, BK, SN, CP

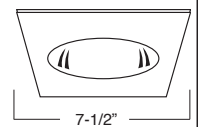

# 6" Incandescent Trims

( LAMP WATTAGE: (1) MAX. 150W R40/PAR38, 120W BR40, 85W BR30, 150W A21)

Catalog Number:

Project Name:

Type:

Note:



**B682WH**  
SQUARE EYEBALL TRIM



TRIM/RING FINISH:  
WH

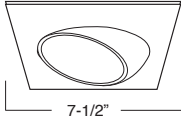

**B693WH**  
SQUARE PAR30 GIMBAL TRIM



TRIM/RING FINISH:  
WH

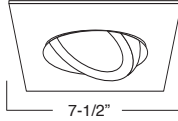

**B694WH**  
SQUARE PAR38 GIMBAL TRIM



TRIM/RING FINISH:  
WH

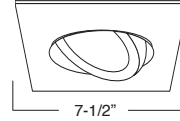

**B688WH**  
SQUARE ALBALITE SHOWER TRIM



LENS:  
WHITE

TRIM/RING FINISH:  
WH

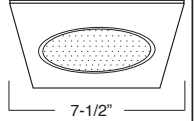

**B685WH**  
SQUARE FRESNEL SHOWER TRIM



LENS:  
CLEAR

TRIM/RING FINISH:  
WH

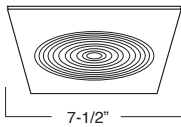

**B696WH**  
SQUARE DROP OIPAL SHOWER TRIM



LENS:  
WHITE

TRIM/RING FINISH:  
WH

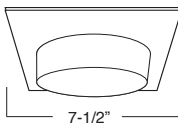

**B689WH**  
SQUARE DESIGNER CONE SHOWER LENS



LENS:  
FROSTED

TRIM/RING FINISH:  
WH

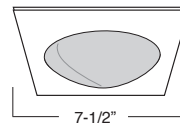

**B680WH**  
SQUARE DESIGNER POINT LENS



LENS:  
FROSTED/CLEAR

TRIM/RING FINISH:  
WH

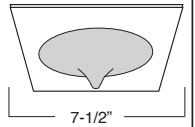

BAFFLE		REFLECTOR		TRIM RING	
<b>W</b>	White	<b>CL</b>	Chrome	<b>WH</b>	White
<b>P</b>	Black	<b>RG</b>	Gold	<b>BK</b>	Black
<b>SN</b>	Satin Nickel	<b>W</b>	White	<b>SN</b>	Satin Nickel
<b>CP</b>	Copper	<b>MB</b>	Black	<b>CP</b>	Copper
<b>BZ</b>	Bronze	<b>CP</b>	Copper	<b>CH</b>	Chrome
		<b>SN</b>	Satin Nickel	<b>PB</b>	Polish Brass
				<b>BZ</b>	Bronze

\*For custom baffle, reflector, trim ring, glass color and lens options, please consult factory.