

Project		Catalog #		Type	
Prepared by		Notes		Date	

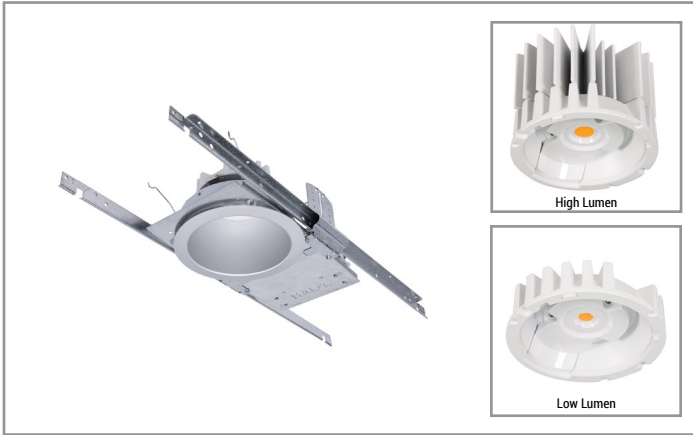

HALO Commercial

HC6 | HM6 | 61 | 61PS

6-inch LED new construction/remodel regressed lens downlight and wall wash

Typical Applications

Office • Healthcare • Hospitality • Institutional • Mixed-Use/Retail

Interactive Menu

- Order Information [page 2](#)
- Product Specifications [page 4](#)
- Photometric Data [page 5](#)
- Energy & Performance Data [page 8](#)
- Product Warranty

Product Certification



Product Features

Top Product Features

- New construction/remodel series; 500 to 4,000 lumens
- Narrow, Medium and Wide distributions; Wall wash with rotatable linear spread lens
- 2700K, 3000K, 3500K and 4000K CCT; 80 or 90 CRI
- Universal voltage 120V-277V; Standard 0-10V driver dims to 1%
- Two retrofit kits install from below ceiling for LED upgrades

Dimensional and Mounting Details

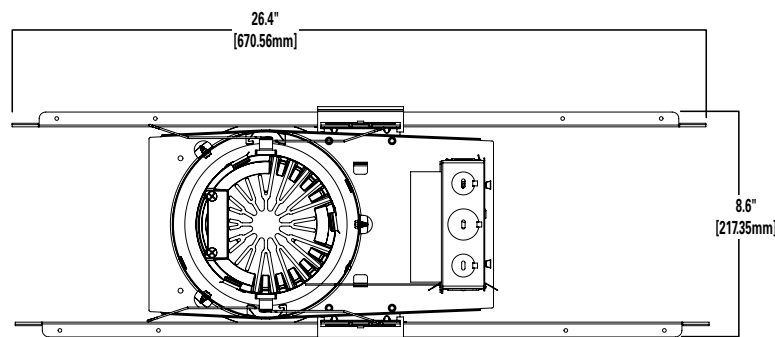

[additional product diagrams](#)

Order Information

Sample Number: HC620D010REM7 – HM612835 - 61MDC

A complete luminaire consists of a housing frame, LED module, and reflector (ordered separately)

Mounting Frame	Lumens	Input / Control	Factory Installed Options	Accessories
HC6 = 6" new construction and remodeler housing HC6CP = 6" new construction and remodeler housing, CCEA Chicago Plenum rated	05 = 500 lumens (nominal) 07 = 750 lumens (nominal) 10 = 1000 lumens (nominal) 15 = 1500 lumens (nominal) 20 = 2000 lumens (nominal) 30 = 3000 lumens (nominal) 40 = 4000 lumens (nominal)	D010=120-277VAC 50/60Hz 0-10V analog 1% - 100% dimming D010347 = 347VAC 50/60Hz 0-10V analog 1%-100% dimming (Canada only) ¹ DLV = Distributed Low Voltage driver, 1%-100% dimming DLV for use with DLVP system only. Refer to DLVP low-voltage power module and DLVP specifications for details. ¹	REM7 = 7 watt emergency module with remote test / indicator light, use with D010 only ¹ REM14 = 14 watt emergency module with remote test / indicator light, use with D010 only ¹ IEM7 = integral 7 watt emergency module with integral test / indicator light, use with D010 only ¹ IEM14 = integral 14 watt emergency module with integral test / indicator light, use with D010 only ¹ BOD7ST = 7.5 watt Bodine self-test diagnostic emergency module with remote test / indicator light, use with D010 only ¹ LWTPD1 = factory installed Enlighted wireless tile mount sensor kit, use with D010 only ¹ WTA=Factory installed WaveLinX tile mount sensor Kit^{1,5} REM7V = 7 watt emergency module with remote test / indicator light, use with DLV only ^{1,2} REM14V = 14 watt emergency module with remote test / indicator light, use with DLV only ^{1,2} IEM7V = integral 7 watt emergency module with integral test / indicator light, use with DLV only ^{1,2} IEM14V = integral 14 watt emergency module with integral test / indicator light, use with DLV only ^{1,2}	HB128APK = L channel hanger bar, 26", pair (replacement) RMB22 = Adjustable wood joist mounting bars, pair, extend to 22" long HSA6=Slope Adapter for 6" Aperture Housings, Specify Slope (refer to instructions for installation of housing and trim) H347 = 347 to 120V step down transformer, 75VA H347200 = 347 to 120V step down transformer, 200VA PORLWTPD1 = Field installed Enlighted wireless sensor kit, use with D010 only ¹ WTA=Factory installed WaveLinX tile mount sensor Kit ^{1,5}
Notes	Notes	Notes	Notes	Notes
		(1) Not available with CP version	(1) Not available with CP version (2) ULus for U.S. only (5) WTA = WaveLinX tile mount sensor kit for daylight dimming, PIR motion sensing, and optional RLTS - Real Time Location Services, use with D010 only (Refer to WaveLinX system specifications)	(1) Not available with CP version (5) WTA = WaveLinX tile mount sensor kit for daylight dimming, PIR motion sensing, and optional RLTS - Real Time Location Services, use with D010 only (Refer to WaveLinX system specifications)

LED Module	Lumens	CRI/CCT
HM6 = 6" LED module	05 = 500 lumens (nominal), use with HC605* housings 07 = 700 lumens (nominal), use with HC607* housings 12=1000, 1500 and 2000 lumens (nominal), use with HC610*, HC615*, HC620* housings 34=3000 and 4000 lumens (nominal), use with HC630*, HC640* housings	827 = 80 CRI (minimum), 2700K CCT 830 = 80 CRI (minimum), 3000K CCT 835 = 80 CRI (minimum), 3500K CCT 840 = 80 CRI (minimum), 4000K CCT 927 = 90 CRI (minimum), 2700K CCT 930 = 90 CRI (minimum), 3000K CCT 935 = 90 CRI (minimum), 3500K CCT 940 = 90 CRI (minimum), 4000K CCT
Notes	Notes	Notes

Reflector	Distribution	Finish	Flange	Accessories
61 = 6" conical reflector	ND = narrow 55° beam angle 0.97 SC MD = medium 60° beam angle 1.10 SC WD = wide 65° beam angle 1.28 SC RWW = rotatable wall wash with linear spread lens	C = Specular clear H = Semi-specular clear W = White	Blank = Polished flange standard with C & H reflectors Blank = White flange standard with W reflector WF = White flange option available with C & H reflectors	61RWWPK = rotatable wall wash insert for 6" reflector –replacement part kit
Notes	Notes	Notes	Notes	Notes
	(3) Values are nominal, with specular clear reflector, other finishes and field results may vary.			

Order Information

Baffle	Distribution	Finish	Flange	Accessories
61 = 6" baffle reflector	WD = wide 65° beam angle 1.28 SC (nominal) RWW = rotatable wall wash with linear spread lens	BB = Black baffle WB = White baffle	Blank = White flange standard with BB, & WB BF = Black flange option available with BB	61RWWPK = rotatable wall wash insert for 6" reflector –replacement part kit
Notes	Notes (3) Values are nominal, with specular clear reflector, other finishes and field results may vary.	Notes	Notes	Notes

IEM Reflector	Distribution	Finish	Flange	Integral Emergency
61 = 6" IEM reflector for integral emergency only	ND = narrow 55° beam angle 0.97 SC MD = medium 60° beam angle 1.10 SC WD = wide 65° beam angle 1.28 SC	C = Specular clear H = Semi-specular clear W = White	Blank = Polished flange standard with C & H reflectors Blank = White flange standard with W reflector WF = White flange option available with C & H reflectors	IEM = Reflector for integral emergency only
Notes	Notes (3) Values are nominal, with specular clear reflector, other finishes and field results may vary.	Notes	Notes	Notes

IEM Baffle	Distribution	Finish	Flange	Integral Emergency
61 = 6" IEM baffle reflector for integral emergency only	WD = wide 65° beam angle 1.28 SC (nominal)	BB = Black baffle WB = White baffle	Blank = White flange standard with BB, & WB BF = Black flange option with BB	IEM = Reflector for integral emergency only
Notes	Notes (3) Values are nominal, with specular clear reflector, other finishes and field results may vary.	Notes	Notes	Notes

Reflector	Distribution	Finish	Flange
61PS = 6" non-conductive polymer 'dead front' conical reflector ⁴	MD = medium 60° beam angle 1.10 SC (nominal)	W = White	Blank = White flange standard with W reflector
Notes (4) 61PS reflector is for Non-IC environment only, and up to 3000 lumens only.	Notes (3) Values are nominal, with specular clear reflector, other finishes and field results may vary.	Notes	Notes

Product Specifications

Housing Frame

- Boat shaped galvanized steel plaster frame with adjustable plaster lip
- Accommodates 1/2" to 1-1/2" thick ceilings
- Installs in new construction or from below the finished ceiling (non-accessible) for remodeling (with mounting bars removed)
- Provided with two remodel clips to secure the frame to the ceiling

Universal Mounting Bracket

- Adjusts 2" vertically from above and below the ceiling
- Use with the included mounting bars or with 1/2" Electric Metallic Tube (EMT)
- Removable to facilitate remodeling installation from below the finished ceiling

Mounting Bars

- Captive pre-installed No Fuss™ mounting bars lock to T-grid with screwdriver or pliers
- Centering detents allow for consistent positioning of fixtures

LED Module

- Proximity phosphors over chip on board LEDs provide a uniform source with high efficiency and no pixilation
- Available in 80 or 90 color rendering index (CRI)
- Color accuracy within 3 SDCM provides color consistency and uniformity
- 90 CRI option: R9>50 (refer to chromaticity information for details)
- Available in 2700K, 3000K, 3500K and 4000K correlated color temperature (CCT)
- Passive thermal management achieves 60,000 hours at 70% lumen maintenance (L70) in insulated ceilings (IC) and non-IC applications
- Integral diffuse lens provides visual shielding
- Integral connector allows quick connection to housing flex

Lumen Options

- Nominal lumen values
 - o 500 lm
 - o 750 lm
 - o 1000 lm
 - o 1500 lm
 - o 2000 lm
 - o 3000 lm
 - o 4000 lm

Reflector

- Self-flanged aluminum reflectors available in narrow, medium or wide distribution patterns
- Medium distribution polymer non-conductive matte white reflector may be used to meet local codes for 'dead front' applications (Non-IC, 3,000 lumens max.)
- Wall wash reflector features a rotatable linear spread lens for alignment of vertical illumination
- Reflectors attach to LED module with three speed clamps
- Available in multiple painted or plated finishes

Reflector/Module Retention

- Reflector/module assembly is securely retained in the housing with two torsion springs

Driver

- Field-replaceable constant current driver provides low noise operation
- Universal 120-277VAC 50/60Hz input standard
- 347VAC 50/60Hz input option (Canada only)
- Continuous, 1% to 100% dimming with 0-10V analog control
- Optional low-voltage DC driver for use with Distributed Low Voltage Power (DLVP) system

Emergency Option

- Provides 90 minutes of standby lighting, meeting most life safety codes for egress lighting
- Available with integral or remote charge indicator and test switch
- Available Self-Test (self-diagnostic) with remote charge indicator and test switch

Connected Lighting Systems Options

- WaveLinx (two options):
 - o Factory installed WaveLinx tile-mount sensor kit includes control module, sensor and cable, allowing use with the comprehensive lighting system
 - o Field installed WaveLinx accessory tile mount sensor kit includes the same components as the factory kit, but sold separately for field installation
 - o WTA WaveLinx tile-mount sensor kit offers daylight dimming, PIR motion sensing control and optional Real Time Location Services (RLTS)
(Refer to WaveLinx system specifications and application guides for details)
 - o WTA WaveLinx kit includes a control module that mounts on the luminaire electrical junction box via a 1/2" knock-out
 - o The WaveLinx tile-mount sensor features direct-mount spring clips to attach to a ceiling tile and the included mounting bracket allows for installation in an octagon ceiling box
- Enlighted wireless tile-mount sensor and control kit
- Distributed Low Voltage Power (DLVP) system combines power, lighting and controls with ease of installation (refer to DLVP Design Guide at www.cooperlighting.com for details)

Junction Box

- Galvanized steel junction box
- 20 in³ internal volume excluding voltage barrier
- 25 in³ internal total volume
- Voltage barrier for 0-10V dimming wires (occupies one 1/2" pry-out space)
- Listed for eight #12 AWG (four in, four out) 90°C conductors and feed-thru branch wiring
- Three 1/2" and two 3/4" trade size pry-outs available
- Three 4-port push wire nuts for mains voltage with 1-port for fixture connection

Compliance

- cULus damp and wet location listed in protected ceilings
- IP20 - Above finished ceiling; IP65 - Below finished ceiling
- Non-Insulated ceiling (Non-IC) rated for 3,000 and 4,000 lumen models (insulation must be kept 3" from top and sides)
- Insulated ceiling (IC) rated for 500, 750, 1,000, 1,500 and 2,000 lumen models and suitable for direct contact with air permeable insulation* (IC models are also suitable for Non-IC installations)
- Airtight per ASTM-E283-04
- Suitable for use in clothes closets when installed in accordance with the NEC 410.16 spacing requirements
- EMI/RFI emissions FCC CFR Title 47 Part 15 Class B at 120V and Class A at 277V
- Contains no mercury or lead and RoHS compliant
- Photometric testing completed in accordance of IES LM-79-08
- Lumen maintenance projection in accordance of IES LM-80-08 and TM-21-11

Warranty

- Five year limited warranty, consult website for details. www.cooperlighting.com/legal

*Not for use in direct contact with spray foam insulation, consult NEMA LSD57-2013

Photometric Data

 View IES files

NARROW DISTRIBUTION - SPECULAR CLEAR FINISH, 2000 LUMEN MODEL, 80 CRI, 3500K

NARROW (55° BEAM*)	
Test Number	P285970
Housing	HC620D010
Module	HM612835
Reflector	61NDC
Lumens	1920 Lm
Efficacy	96 Lm/W
SC	0.97
UGR	11.7

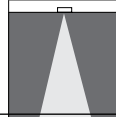
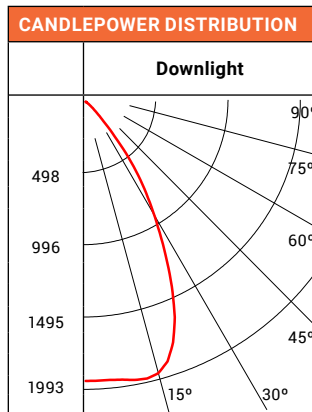
CONE OF LIGHT				
				
MH	FC	L	W	
5.5'	64.9	5.2	5.2	
7'	40	6.8	6.8	
8'	30.7	7.6	7.6	
9'	24.2	8.6	8.6	
10'	19.6	9.6	9.6	
12'	13.6	11.6	11.6	

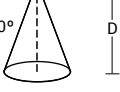
CANDELA TABLE	
Degrees Vertical	Candela
0	1962
5	1962
15	1975
25	1434
35	671
45	112
55	13
65	3
75	3
85	0
90	0

ZONAL LUMEN SUMMARY		
Zone	Lumens	% Fixture
0-30	1385	72.1
0-40	1796	93.5
0-60	1915	99.7
0-90	1920	100
90-180	0	0
0-180	1920	100

LUMINANCE	
Average Candela Degrees	Average 0° Luminance
45	8706
55	1223
65	337
75	551
85	0

MEDIUM DISTRIBUTION - SPECULAR CLEAR FINISH, 2000 LUMEN MODEL, 80 CRI, 3500K

MEDIUM (60° BEAM*)	
Test Number	P286170
Housing	HC620D010
Module	HM612835
Reflector	61MDC
Lumens	1959 Lm
Efficacy	97.9 Lm/W
SC	1.10
UGR	11.8

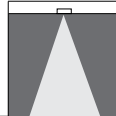
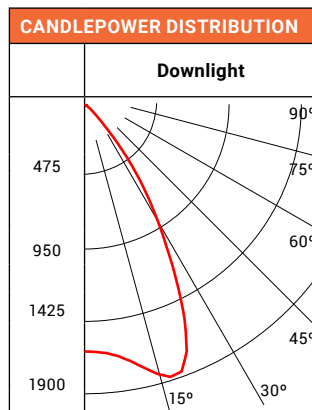
CONE OF LIGHT				
				
MH	FC	L	W	
5.5'	55.2	5.8	5.8	
7'	34.1	7.6	7.6	
8'	26.1	8.6	8.6	
9'	20.6	9.6	9.6	
10'	16.7	10.8	10.8	
12'	11.6	13	13	

CANDELA TABLE	
Degrees Vertical	Candela
0	1642
5	1660
15	1854
25	1576
35	699
45	120
55	15
65	5
75	3
85	0
90	0

ZONAL LUMEN SUMMARY		
Zone	Lumens	% Fixture
0-30	1387	70.8
0-40	1821	93
0-60	1951	99.6
0-90	1959	100
90-180	0	0
0-180	1959	100

LUMINANCE	
Average Candela Degrees	Average 0° Luminance
45	9236
55	1462
65	662
75	551
85	0

WIDE DISTRIBUTION - SPECULAR CLEAR FINISH, 2000 LUMEN MODEL, 80 CRI, 3500K

WIDE (65° BEAM*)	
Test Number	P286370
Housing	HC620D010
Module	HM612835
Reflector	61WDC
Lumens	2045 Lm
Efficacy	102.3 Lm/W
SC	1.28
UGR	11.6

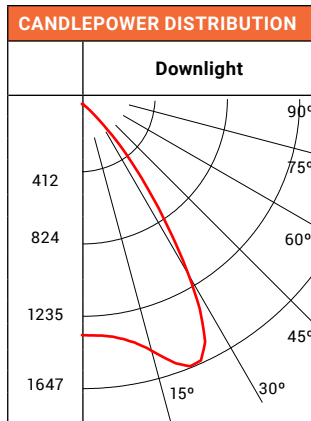
CONE OF LIGHT			
MH	FC	L	W
5.5'	44.3	7	7
7'	27.4	8.8	8.8
8'	21	10.2	10.2
9'	16.6	11.4	11.4
10'	13.4	12.6	12.6
12'	9.3	15.2	15.2

CANDELA TABLE	
Degrees Vertical	Candela
0	1341
5	1349
15	1466
25	1642
35	877
45	201
55	28
65	5
75	2
85	0
90	0

ZONAL LUMEN SUMMARY		
Zone	Lumens	% Fixture
0-30	1282	62.7
0-40	1835	89.7
0-60	2037	99.6
0-90	2045	100
90-180	0	0
0-180	2045	100

LUMINANCE	
Average Candela Degrees	Average 0° Luminance
45	15614
55	2676
65	662
75	530
85	0

*Value are nominal with specular clear reflectors, other finishes and field results may vary.
 SC = Spacing Criteria
 UGR = Unified Glare Rating

Photometric Multipliers (Nominal Lumen Values)

500 Lumen	750 Lumen	1000 Lumen	1500 Lumen	2000 Lumen	3000 LUMEN	4000 LUMEN
0.32	0.42	0.52	0.72	1.00	1.44	2.02

Multipliers for relative lumen values with other series models.

Color Finish Multipliers

Finish code	C	H	W/WB	BB
Finish	Specular Clear	Semi-Specular	Matte White White Baffle	Black Baffle
Multiplier	1.00	0.91	0.92	0.84

Multipliers for relative lumen values with other color finishes.

CCT Multipliers - 80CRI

2700K	3000K	3500K	4000K
0.93	0.95	1.00	1.05

Multipliers for relative lumen values with other series color temperatures.

CCT Multipliers - 90CRI

2700K	3000K	3500K	4000K
0.75	0.82	0.90	0.89

Multipliers for relative lumen values with other series color temperatures.

WALL WASH DISTRIBUTION - SPECULAR CLEAR FINISH, 2000 LUMEN MODEL, 80 CRI, 3500K

WALL WASH	
Test Number	P286650
Housing	HC620D010
Module	HM612835
Reflector	61RWWC
Lumens	1798 Lm
Efficacy	89.9 Lm/W
SC	1.23

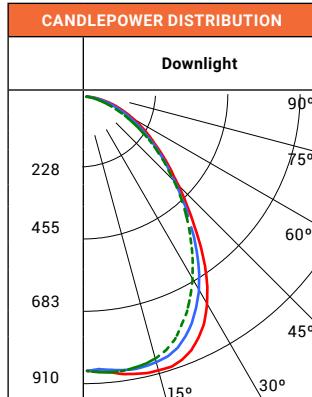

CANDELA TABLE	
Degrees Vertical	Candela
0	882
5	890
15	910
25	854
35	665
45	431
55	270
65	161
75	74
85	10
90	0

ZONAL LUMEN SUMMARY		
Zone	Lumens	% Fixture
0-30	696	38.7
0-40	1079	60
0-60	1629	90.6
0-90	1798	100
90-180	0	0
0-180	1798	100

LUMINANCE	
Average Candela Degrees	Average 0° Luminance
45	33399
55	25825
65	20832
75	15653
85	6416

SC = Spacing Criteria, nominal for specular clear reflector, other finishes and field results may vary.

SINGLE UNIT FOOTCANDLES							
2.5' from wall (distance from fixture along wall)							
1	16.8	12	5.4	2	0.7	0.2	0.1
2	24.7	19.2	10.5	4.9	2.2	1	0.5
3	22.8	18.6	11.4	6.2	3.2	1.7	0.9
4	17.5	15	10.3	6.2	3.6	2	1.2
5	11.9	10.7	8.2	5.5	3.4	2.1	1.3
6	8	7.4	6.1	4.5	3.1	2	1.3
7	5.5	5.2	4.5	3.6	2.6	1.9	1.3
8	3.9	3.7	3.3	2.8	2.2	1.6	1.2
9	2.8	2.7	2.5	2.2	1.8	1.4	1.1
10	2.1	2	1.9	1.7	1.5	1.2	0.9

MULTIPLE UNIT FOOTCANDLES						
2.5' from wall (Distance from fixture along 3')			2.5' from wall (Distance from fixture along 4')			
1	18.8	16.6	18.8	17.5	10.7	17.5
2	29.5	29.2	29.5	26.8	20.9	26.8
3	29	29.8	29	26	22.9	26
4	23.7	25.3	23.7	21	20.5	21
5	17.4	19.2	17.4	15.4	16.3	15.4
6	12.5	13.7	12.5	11.1	12.2	11.1
7	9.1	9.8	9.1	8.1	9	8.1
8	6.7	7.1	6.7	6.1	6.7	6.1
9	5	5.3	5	4.6	5	4.6
10	3.8	4	3.8	3.5	3.8	3.5

Photometric Multipliers (Nominal Lumen Values)

500 Lumen	750 Lumen	1000 Lumen	1500 Lumen	2000 Lumen	3000 LUMEN	4000 LUMEN
0.32	0.42	0.52	0.72	1.00	1.44	2.02

Multipliers for relative lumen values with other series models.

Color Finish Multipliers

Finish code	C	H	W/WB	BB
Finish	Specular Clear	Semi-Specular	Matte White White Baffle	Black Baffle
Multiplier	1.00	0.91	0.92	0.84

Multipliers for relative lumen values with other color finishes.

CCT Multipliers – 80CRI

2700K	3000K	3500K	4000K
0.93	0.95	1.00	1.05

Multipliers for relative lumen values with other series color temperatures.

CCT Multipliers – 90CRI

2700K	3000K	3500K	4000K
0.75	0.82	0.90	0.89

Multipliers for relative lumen values with other series color temperatures.

Energy & Performance Data

Series	500 lumen	
Input Voltage 120-277VAC	120V	277V
Input Current (A)	TBD	TBD
Input Power (W)	TBD	TBD
In-rush Current (A)	TBD	TBD
In-rush Duration (ms)	TBD	TBD
THDi (%)	TBD	TBD
PF:	≥ 0.90	
(Nominal input 120-277VAC & 100% of rated output power)		
Minimum starting temperature	-40°C (-40°F)*	
Sound Rating:	Class A standards	

Series	750 lumen	
Input Voltage 120-277VAC	120V	277V
Input Current (A)	TBD	TBD
Input Power (W)	TBD	TBD
In-rush Current (A)	TBD	TBD
In-rush Duration (ms)	TBD	TBD
THDi (%)	TBD	TBD
PF:	≥ 0.90	
(Nominal input 120-277VAC & 100% of rated output power)		
Minimum starting temperature	-40°C (-40°F)*	
Sound Rating:	Class A standards	

Series	1000 lumen	
Input Voltage 120-277VAC	120V	277V
Input Current (A)	0.085	0.042
Input Power (W)	10.1	10.9
In-rush Current (A)	0.644	1.95
In-rush Duration (ms)	0.125	0.24
THDi (%)	8.6	15.6
PF:	≥ 0.90	
(Nominal input 120-277VAC & 100% of rated output power)		
Minimum starting temperature	-30°C (-22°F)*	
Sound Rating:	Class A standards	

Series	1500 lumen	
Input Voltage 120-277VAC	120V	277V
Input Current (A)	0.119	0.055
Input Power (W)	14.2	14.9
In-rush Current (A)	0.212	0.85
In-rush Duration (ms)	0.28	0.32
THDi (%)	7.8	16.3
PF:	≥ 0.90	
(Nominal input 120-277VAC & 100% of rated output power)		
Minimum starting temperature	-30°C (-22°F)*	
Sound Rating:	Class A standards	

Series	2000 lumen	
Input Voltage 120-277VAC	120V	277V
Input Current (A)	0.176	0.082
Input Power (W)	21.1	21.4
In-rush Current (A)	0.588	0.624
In-rush Duration (ms)	0.3	0.38
THDi (%)	8.8	11.2
PF:	≥ 0.90	
(Nominal input 120-277VAC & 100% of rated output power)		
Minimum starting temperature	-30°C (-22°F)*	
Sound Rating:	Class A standards	

Series	3000 lumen	
Input Voltage 120-277VAC	120V	277V
Input Current (A)	0.228	0.102
Input Power (W)	27.2	27
In-rush Current (A)	0.898	1.7
In-rush Duration (ms)	0.36	0.38
THDi (%)	9.7	9.3
PF:	≥ 0.90	
(Nominal input 120-277VAC & 100% of rated output power)		
Minimum starting temperature	-30°C (-22°F)*	
Sound Rating:	Class A standards	

Series	4000 lumen	
Input Voltage 120-277VAC	120V	277V
Input Current (A)	0.345	0.15
Input Power (W)	41.3	40.7
In-rush Current (A)	1.05	2.23
In-rush Duration (ms)	0.32	0.34
THDi (%)	10.06	14.01
PF:	≥ 0.90	
(Nominal input 120-277VAC & 100% of rated output power)		
Minimum starting temperature	-30°C (-22°F)*	
Sound Rating:	Class A standards	

Notes:
* Emergency Battery packs are rated for a minimum starting temperature of 0°C.

Energy & Performance Data

COLOR METRICS - TM-30-15 & CRI/CIE (3500K)

80 CRI Color Metric Summary - 3500K*

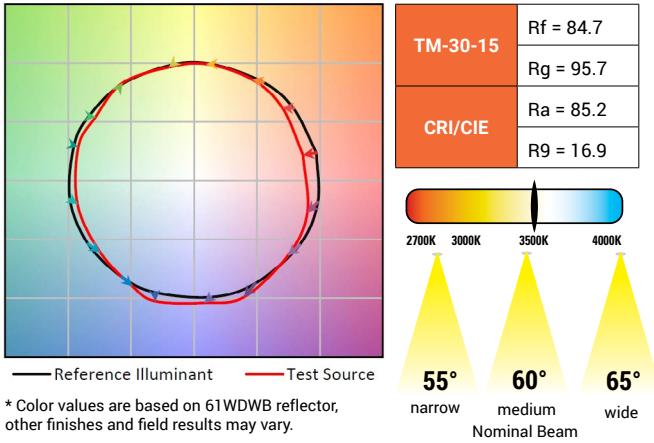

90 CRI Color Metric Summary - 3500K*

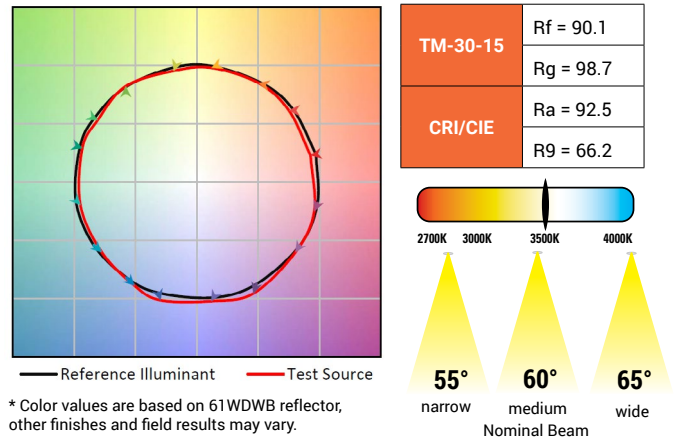

Dimensional and Mounting Details

NEW CONSTRUCTIONS - HIGH LUMEN 3000 AND 4000 LUMEN

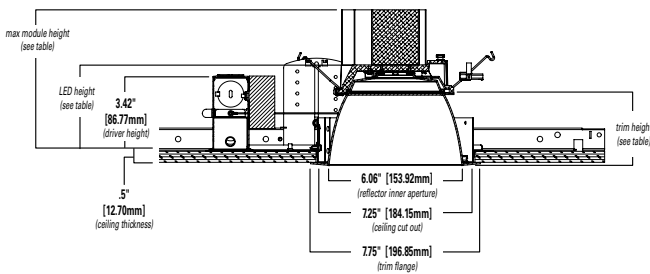

NEW CONSTRUCTIONS - LOW LUMEN 1000, 1500, AND 2000 LUMEN

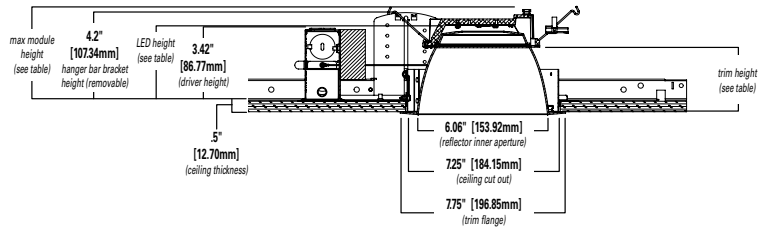

High Lumen (3000 & 4000 Lumens)

Distribution	Max. Module Height	Trim Height	LED Height
Narrow	6.6"	3.4"	3.8"
Medium	6.7"	3.5"	3.9"
Wide	6.5"	3.3"	3.7"
Baffle	6.5"	3.3"	3.7"

Low Lumen (500, 750, 1000, 1500 & 2000 Lumens)*

Max. Module Height	Trim Height	LED Height
4.5"	3.4"	3.8"
4.6"	3.5"	3.9"
4.4"	3.3"	3.7"
4.4"	3.3"	3.7"

*Max. height w/hanger bar bracket 4.2"