

DESCRIPTION

Recessed 6-inch LED lens downlight is available in various distributions, lumen and CRI/CCT options. Suitable for commercial construction and can be used for both new or renovation work. Use for general area lighting where high efficiency and visual comfort are required.

Catalog #	PD615D010BREM	Type
Project		
Comments		Date
Prepared by		

SPECIFICATION FEATURES

MECHANICAL

Frame

Boat shaped galvanized steel frame with adjustable plaster lip accommodates ceilings up to ½ - 2" thick. May be used for new construction or remodeling installations. Provided with (2) remodel clips to secure frame when installed from below the ceiling.

Mounting Brackets

Bar hanger receivers adjusts 2" vertically from above the ceiling or thru the aperture. Use with No Fuss™ bar hangers or with ½" EMT. Removable to facilitate installation from below the ceiling.

No Fuss™ Bar Hangers

Captive preinstalled bar hanger locks to tee grid with a screwdriver or pliers. Centering mechanism allows consistent positioning of fixtures.

OPTICAL

LED Module

Proximity phosphors over chip on board LEDs provide a uniform source with high efficiency and no pixilation. Available in 80 or 90 CRI minimum, accuracy within 3 SDCM provides color uniformity. See ordering information for available CRI / CCT options. Passive thermal management achieves L70 at 50,000 hours in non IC applications. Integral diffuse lens provides visual shielding. Integral connector allows quick connection to housing flex.

Reflector

One piece parabolic aluminum reflector provides cutoff for a visually comfortable optic. Attaches to LED module with (3) speed clamps minimizing light leaks to lens. Self-flanged standard with an optional white painted flange.

Trim Retention

Reflectors are retained with two torsion springs holding the flange tightly to the finished ceiling surface.

ELECTRICAL Junction Box

(6) ½" and (2) ¾" trade size pry outs positioned to allow straight conduit runs. Listed for (12) #12 AWG (six in, six out) 90°C conductors and feed thru branch wiring.

Driver

Integral UNV 120 - 277V 50/60 Hz constant current driver provides noise free operation. For 347V input use Halo transformer H347 or H347200. Continuous, flicker-free dimming from 100% to 1% with 0 -10V analog control. Optional low voltage DC driver for use with Eaton's distributed low voltage power system.

Emergency Option

Provides 90 minutes of standby lighting meeting most life safety codes for egress lighting. Available with both integral or remote charge indicator and test switch.

Compliance

- cULus listed for wet location.
- IP66 Ingress Protection Rated.
- Non-IC rated for 2000 and 3000 Lumen fixtures. Insulation must be kept 3" from top and sides.
- IC rated for 1000 and 1500 Lumen fixtures.
- Airtight per ASTM-E283.
- Optional City of Chicago environmental air (CCEA) marking for plenum applications.
- EMI/RFI emissions per FCC 47CFR Part 18 non-consumer limits.
- Contains no mercury or lead and RoHS compliant.
- Photometric testing in accordance with IES LM-79-08.
- Lumen maintenance projections in accordance with IES LM-80-08 and TM-21-11.
- 80 CRI:
- Can be used to comply with California Title 24 Non-Residential Lighting Controls requirements as a LED Luminaire.
- ENERGY STAR® listed for commercial applications, reference database for current listings.

WARRANTY

Limited 5-year warranty, see website for details.
www.eaton.com/lighting/legal



PD610
PD615
PD620
PD630

PDM6B

61V

1000, 1500,
2000 & 3000
Lumen Series

LED
6-Inch Aperture
Lens Downlight

THD: ≤ 20%
PF: ≥ 0.90
T Ambient -30 - +40°C
Sound Rating ≤ 20 dba

Lumens	1000 Series	
Input Voltage	120V	277V
Input Current	0.083A	0.041 A
Input Power	9.9 W	10.8 W
Efficacy	120 LPW	120 LPW
Inrush Current	0.53 A	1.3 A

Lumens	1500 Series	
Input Voltage	120V	277V
Input Current	0.114 A	0.053 A
Input Power	13.7 W	14.3 W
Efficacy	120 LPW	120 LPW
Inrush Current	0.63 A	1.7 A

Lumens	2000 Series	
Input Voltage	120V	277V
Input Current	0.166 A	0.079 A
Input Power	19.9 W	20.5 W
Efficacy	115 LPW	115 LPW
Inrush Current	0.59 A	2.7 A

Lumens	3000 Series	
Input Voltage	120V	277V
Input Current	0.232 A	0.103 A
Input Power	27.7 W	27.5 W
Efficacy	110 LPW	110 LPW
Inrush Current	0.73 A	2.9 A

ORDERING INFORMATION

SAMPLE NUMBER: PD610D010BREM-PDM6B827-61VC

A complete luminaire consists of a housing, LED module and reflector, order separately.

Housing	Lumens	Driver	Options	LED Module	CRI/CCT
PD6 = 6" aperture LED downlight PD6CP = 6" aperture LED downlight, CCEA listed for City of Chicago plenum requirements	10 = 1,000 lumens (nominal) 15 = 1,500 lumens (nominal) 20 = 2,000 lumens (nominal) 30 = 3,000 lumens (nominal)	D010B = 120-277V 50/60Hz, 0-10V dimming DLV = Low voltage dimming driver	REM = Emergency operation with remote indicator and test switch ^{1,2} REMV7 = 7W low voltage emergency module with remote test switch ^{1,2} REMV14 = 14W low voltage emergency module with remote test switch ^{1,2} IEM = Emergency operation with integral indicator and test switch, 60 Hz only (REM and IEM options not available with PD6CP housing) ^{1,2} IEMV7 = 7W low voltage emergency module with integral test switch ^{1,2} IEMV14 = 14W low voltage emergency module with integral test switch ^{1,2} LWTPD1 = Factory installed LumaWatt Pro Wireless Sensor Kit (0-10V only) SWPD1 = Factory installed WaveLinX tilemount daylight sensor (includes control module, sensor, cable and tile mount)	PDM6B = Downlight LED module for PD6 housing, provides 1,000, 1,500, 2,000, or 3,000 lumens (nominal) depending on connected housing type	827 = 80 CRI, 2700K CCT 927 = 90 CRI, 2700K CCT 830 = 80 CRI, 3000K CCT 930 = 90 CRI, 3000K CCT 835 = 80 CRI, 3500K CCT 935 = 90 CRI, 3500K CCT 840 = 80 CRI, 4000K CCT 940 = 90 CRI, 4000K CCT

Reflector	Finish Option	Flange Option	Accessories
61V = 6" vertical parabolic reflector 61VEM = 6" vertical parabolic reflector for IEM	C = Specular clear G = Specular gold H = Semi-specular clear W = White (white flange) BB = Black baffle (white flange) WB = White baffle (white flange)	Blank = Polished flange standard with C, G & H reflector finishes Blank = White flange standard with W, BB, & WB WF = White flange option available with C, G, & H reflector finishes	HB128APK = L channel hanger bar, 26", 'No-Fuss', pair (replacement) RMB22 = 22" long wood joist mounting bars, pair H347 = Step down transformer for 347V input H347 = Step down transformer for 347V input, 75VA max H347200 = Step down transformer for 347V input, 200VA max PORLWTPD1 = LumaWatt Pro Wireless Sensor Kit (0-10V only) TMSWPD1 = WaveLinX tilemount daylight sensor (includes control module, sensor, cable and tile mount)

Notes: 1. Not available with CP version.
2. UL qualified for US only (not Canada).

DIMENSIONS

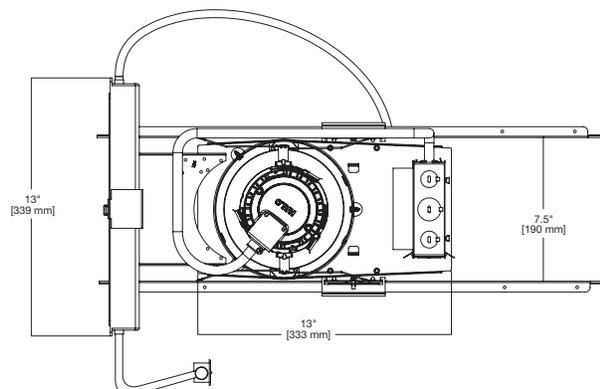
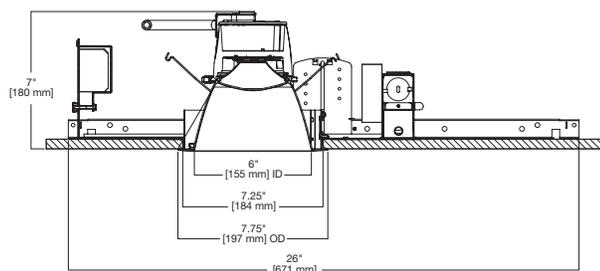
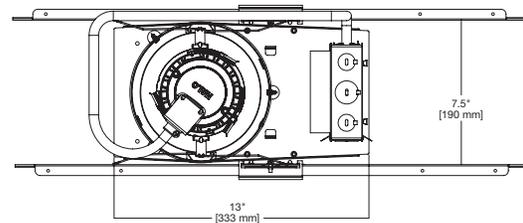
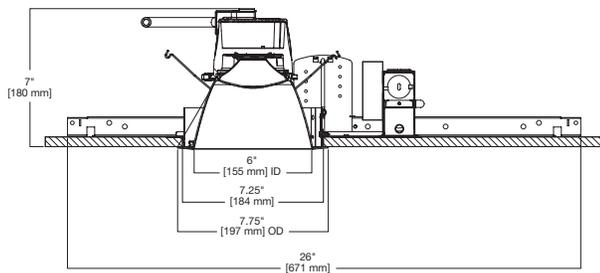

COMPLIANCE TABLE

1000 LUMEN

80 CRI								
Catalog #	PD610D010B-PDM6B827		PD610D010B-PDM6B830		PD610D010B-PDM6B835		PD610D010B-PDM6B840	
	LUMENS	LPW	LUMENS	LPW	LUMENS	LPW	LUMENS	LPW
61VC	1102	111	1169	118	1200	121	1223	124
61VCWF	1078	109	1143	115	1174	119	1196	121
61VG	1077	109	1142	115	1172	118	1195	121
61VGWF	1033	104	1095	111	1125	114	1146	116
61VH	1009	102	1069	108	1098	111	1119	113
61VHWF	1007	102	1067	108	1096	111	1117	113
61VW	1113	112	1181	119	1212	122	1235	125
61VBB	946	96	1003	101	1030	104	1050	106
61VWB	1066	108	1131	114	1161	117	1183	119

90 CRI								
Catalog #	PD610D010B-PDM6B927		PD610D010B-PDM6B930		PD610D010B-PDM6B935		PD610D010B-PDM6B940	
	LUMENS	LPW	LUMENS	LPW	LUMENS	LPW	LUMENS	LPW
61VC	941	95	995	100	1053	106	1069	108
61VCWF	920	93	973	98	1030	104	1045	106
61VG	919	93	972	98	1029	104	1044	105
61VGWF	881	89	932	94	987	100	1002	101
61VH	861	87	910	92	963	97	978	99
61VHWF	859	87	908	92	962	97	976	99
61VW	950	96	1005	101	1063	107	1080	109
61VBB	807	82	854	86	904	91	918	93
61VWB	910	92	962	97	1019	103	1034	104

1500 LUMEN

80 CRI								
Catalog #	PD615D010B-PDM6B827		PD615D010B-PDM6B830		PD615D010B-PDM6B835		PD615D010B-PDM6B840	
	LUMENS	LPW	LUMENS	LPW	LUMENS	LPW	LUMENS	LPW
61VC	1497	109	1587	116	1630	119	1660	121
61VCWF	1464	107	1552	113	1593	116	1624	119
61VG	1462	107	1550	113	1592	116	1622	118
61VGWF	1402	102	1487	109	1527	111	1556	114
61VH	1369	100	1452	106	1491	109	1519	111
61VHWF	1367	100	1449	106	1488	109	1516	111
61VW	1512	110	1603	117	1646	120	1677	122
61VBB	1285	94	1362	99	1399	102	1425	104
61VWB	1448	106	1535	112	1576	115	1606	117

90 CRI								
Catalog #	PD615D010B-PDM6B927		PD615D010B-PDM6B930		PD615D010B-PDM6B935		PD615D010B-PDM6B940	
	LUMENS	LPW	LUMENS	LPW	LUMENS	LPW	LUMENS	LPW
61VC	1277	93	1350	99	1429	104	1451	106
61VCWF	1249	91	1321	96	1398	102	1419	104
61VG	1247	91	1319	96	1396	102	1417	103
61VGWF	1197	87	1265	92	1339	98	1360	99
61VH	1168	85	1235	90	1308	95	1328	97
61VHWF	1166	85	1233	90	1305	95	1325	97
61VW	1290	94	1364	100	1444	105	1466	107
61VBB	1096	80	1159	85	1227	90	1246	91
61VWB	1235	90	1306	95	1383	101	1404	102

COMPLIANCE TABLE continued

2000 LUMEN

80 CRI								
Catalog #	PD620D010B-PDM6B827		PD620D010B-PDM6B830		PD620D010B-PDM6B835		PD620D010B-PDM6B840	
	LUMENS	LPW	LUMENS	LPW	LUMENS	LPW	LUMENS	LPW
61VC	2119	106	2247	113	2307	116	2351	118
61VCWF	2072	104	2197	110	2256	113	2299	116
61VG	2070	104	2194	110	2253	113	2296	115
61VGWF	1985	100	2105	106	2162	109	2202	111
61VH	1938	97	2055	103	2111	106	2150	108
61VHWF	1935	97	2052	103	2107	106	2147	108
61VW	2140	108	2269	114	2330	117	2374	119
61VBB	1819	91	1929	97	1980	100	2018	101
61VWB	2050	103	2173	109	2232	112	2274	114

90 CRI								
Catalog #	PD620D010B-PDM6B927		PD620D010B-PDM6B930		PD620D010B-PDM6B935		PD620D010B-PDM6B940	
	LUMENS	LPW	LUMENS	LPW	LUMENS	LPW	LUMENS	LPW
61VC	1808	91	1912	96	2024	102	2055	103
61VCWF	1768	89	1870	94	1979	99	2009	101
61VG	1766	89	1868	94	1977	99	2007	101
61VGWF	1694	85	1791	90	1896	95	1925	97
61VH	1654	83	1749	88	1852	93	1880	94
61VHWF	1651	83	1746	88	1848	93	1876	94
61VW	1826	92	1931	97	2044	103	2075	104
61VBB	1552	78	1641	82	1737	87	1764	89
61VWB	1749	88	1850	93	1958	98	1988	100

3000 LUMEN

80 CRI								
Catalog #	PD630D010B-PDM6B827		PD630D010B-PDM6B830		PD630D010B-PDM6B835		PD630D010B-PDM6B840	
	LUMENS	LPW	LUMENS	LPW	LUMENS	LPW	LUMENS	LPW
61VC	2763	100	2929	107	3008	109	3065	111
61VCWF	2701	98	2864	104	2941	107	2997	109
61VG	2698	98	2861	104	2938	107	2993	109
61VGWF	2588	94	2744	100	2818	102	2871	104
61VH	2527	92	2680	97	2752	100	2804	102
61VHWF	2523	92	2675	97	2747	100	2798	102
61VW	2790	101	2958	108	3038	110	3095	113
61VBB	2371	86	2514	91	2582	94	2631	96
61VWB	2672	97	2833	103	2910	106	2965	108

90 CRI								
Catalog #	PD630D010B-PDM6B927		PD630D010B-PDM6B930		PD630D010B-PDM6B935		PD630D010B-PDM6B940	
	LUMENS	LPW	LUMENS	LPW	LUMENS	LPW	LUMENS	LPW
61VC	2357	86	2493	91	2639	96	2679	97
61VCWF	2305	84	2438	89	2580	94	2619	95
61VG	2302	84	2435	89	2577	94	2616	95
61VGWF	2209	80	2336	85	2472	90	2510	91
61VH	2156	78	2280	83	2414	88	2450	89
61VHWF	2152	78	2276	83	2409	88	2446	89
61VW	2381	87	2518	92	2665	97	2705	98
61VBB	2023	74	2140	78	2265	82	2299	84
61VWB	2280	83	2411	88	2552	93	2591	94

PHOTOMETRY - 1000 lumen / 80 CRI

PD610D010B-PDM6B835-61VC
Spacing Criteria = 0.72
Lumens per Watt = 121.2 Lm/W
Test No. P215328
Test Model: PD610D010B-PDM6B835-61VC

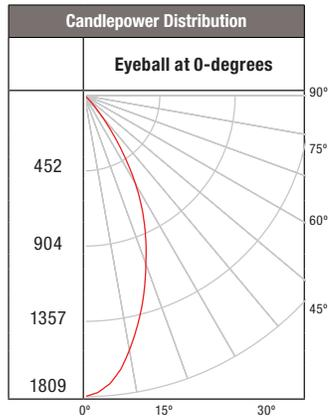

Candela Distribution	
Degrees Vertical	Candela
0*	1809
5	1739
10	1553
20	1077
30	611
40	160
50	18
60	3
70	1
80	0
90	0

*CBCP

Luminance	
(Average Candela/M ²)	
Degree	Avg. 0° Luminance
45	4528
55	507
65	169
75	148
85	0

Cone of Light Footcandles			
Distance to Illuminated Plane	Initial Nadir Footcandles	Beam (ft.)	
		L Length	W Width
5.5'	59.8	3.8	3.8
7'	36.9	5	5
8'	28.3	5.6	5.6
9'	22.3	6.4	6.4
10'	18.1	7.2	7.2
12'	12.6	8.6	8.6

Beam diameter is to 50% of maximum footcandles, rounded to the nearest half-foot. Footcandle values are initial, apply appropriate light loss factors where necessary.

Zonal Lumen Summary		
Zone	Lumens	% Fixture
0-30	914	76.1
0-40	1139	94.9
0-60	1198	99.8
0-90	1200	100

PHOTOMETRY - 1000 lumen / 90 CRI

PD610D010B-PDM6B935-61VC
Spacing Criteria = 0.72
Lumens per Watt = 106.4 Lm/W
Test No. P215332
Test Model: PD610D010B-PDM6B935-61VC

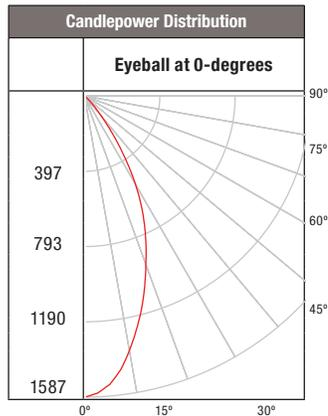

Candela Distribution	
Degrees Vertical	Candela
0*	1587
5	1526
10	1363
20	945
30	536
40	140
50	16
60	2
70	1
80	0
90	0

*CBCP

Luminance	
(Average Candela/M ²)	
Degree	Avg. 0° Luminance
45	3969
55	449
65	156
75	127
85	0

Cone of Light Footcandles			
Distance to Illuminated Plane	Initial Nadir Footcandles	Beam (ft.)	
		L Length	W Width
5.5'	52.5	3.8	3.8
7'	32.4	5	5
8'	24.8	5.6	5.6
9'	19.6	6.4	6.4
10'	15.9	7.2	7.2
12'	11	8.6	8.6

Beam diameter is to 50% of maximum footcandles, rounded to the nearest half-foot. Footcandle values are initial, apply appropriate light loss factors where necessary.

Zonal Lumen Summary		
Zone	Lumens	% Fixture
0-30	802	76.1
0-40	999	94.9
0-60	1051	99.8
0-90	1053	100

PHOTOMETRY - 1500 lumen / 80 CRI

PD615D010B-PDM6B835-61VC

Spacing Criteria = 0.72

Lumens per Watt = 118.9 Lm/W

Test No. P215312

Test Model: PD615D010B-PDM6B835-61VC

Candlepower Distribution

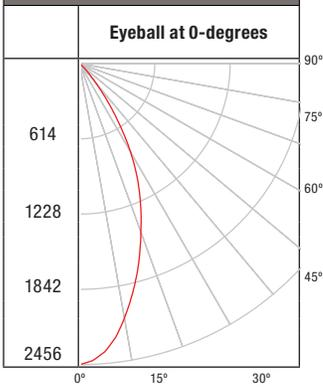

Candela Distribution	
Degrees Vertical	Candela
0*	2456
5	2361
10	2109
20	1463
30	830
40	217
50	24
60	4
70	1
80	0
90	0

*CBCP

Luminance	
(Average Candela/M ²)	
Degree	Avg. 0° Luminance
45	6148
55	688
65	233
75	191
85	0

Cone of Light Footcandles			
Distance to Illuminated Plane	Initial Nadir Footcandles	Beam (ft.)	
		L Length	W Width
5.5'	81.2	3.8	3.8
7'	50.1	5	5
8'	38.4	5.6	5.6
9'	30.3	6.4	6.4
10'	24.6	7.2	7.2
12'	17.1	8.6	8.6

Beam diameter is to 50% of maximum footcandles, rounded to the nearest half-foot. Footcandle values are initial, apply appropriate light loss factors where necessary.

Zonal Lumen Summary

Zone	Lumens	% Fixture
0-30	1241	76.1
0-40	1546	94.9
0-60	1627	99.8
0-90	1629	100

PHOTOMETRY - 1500 lumen / 90 CRI

PD615D010B-PDM6B935-61VC

Spacing Criteria = 0.72

Lumens per Watt = 104.3 Lm/W

Test No. P215316

Test Model: PD615D010B-PDM6B935-61VC

Candlepower Distribution

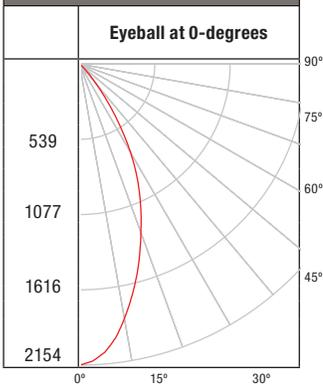

Candela Distribution	
Degrees Vertical	Candela
0*	2154
5	2071
10	1850
20	1283
30	728
40	190
50	21
60	3
70	1
80	0
90	0

*CBCP

Luminance	
(Average Candela/M ²)	
Degree	Avg. 0° Luminance
45	5396
55	602
65	208
75	169
85	0

Cone of Light Footcandles			
Distance to Illuminated Plane	Initial Nadir Footcandles	Beam (ft.)	
		L Length	W Width
5.5'	71.2	3.8	3.8
7'	44	5	5
8'	33.7	5.6	5.6
9'	26.6	6.4	6.4
10'	21.5	7.2	7.2
12'	15	8.6	8.6

Beam diameter is to 50% of maximum footcandles, rounded to the nearest half-foot. Footcandle values are initial, apply appropriate light loss factors where necessary.

Zonal Lumen Summary

Zone	Lumens	% Fixture
0-30	1088	76.1
0-40	1356	94.9
0-60	1427	99.8
0-90	1429	100

PHOTOMETRY - 2000 lumen / 80 CRI

PD620D010B-PDM6B835-61VC
Spacing Criteria = 0.72
Lumens per Watt = 115.9 Lm/W
Test No. P215296
Test Model: PD620D010B-PDM6B835-61VC

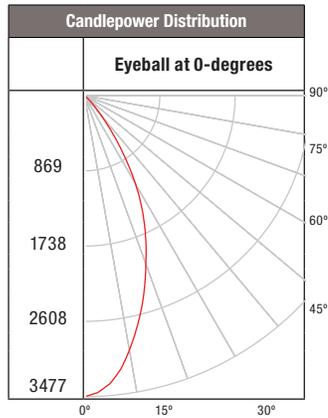

Candela Distribution	
Degrees Vertical	Candela
0*	3477
5	3343
10	2986
20	2071
30	1175
40	308
50	34
60	5
70	1
80	0
90	0

*CBCP

Luminance	
(Average Candela/M ²)	
Degree	Avg. 0° Luminance
45	8706
55	975
65	337
75	275
85	0

Cone of Light Footcandles			
Distance to Illuminated Plane	Initial Nadir Footcandles	Beam (ft.)	
		L Length	W Width
5.5'	114.9	3.8	3.8
7'	71	5	5
8'	54.3	5.6	5.6
9'	42.9	6.4	6.4
10'	34.8	7.2	7.2
12'	24.1	8.6	8.6

Beam diameter is to 50% of maximum footcandles, rounded to the nearest half-foot. Footcandle values are initial, apply appropriate light loss factors where necessary.

Zonal Lumen Summary		
Zone	Lumens	% Fixture
0-30	1757	76.1
0-40	2189	94.9
0-60	2303	99.8
0-90	2307	100

PHOTOMETRY - 2000 lumen / 90 CRI

PD620D010B-PDM6B935-61VC
Spacing Criteria = 0.72
Lumens per Watt = 101.7 Lm/W
Test No. P215300
Test Model: PD620D010B-PDM6B935-61VC

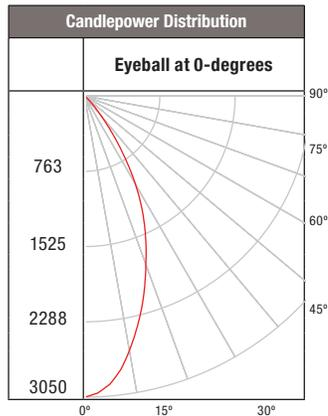

Candela Distribution	
Degrees Vertical	Candela
0*	3050
5	2932
10	2619
20	1817
30	1031
40	270
50	30
60	4
70	1
80	0
90	0

*CBCP

Luminance	
(Average Candela/M ²)	
Degree	Avg. 0° Luminance
45	7636
55	860
65	285
75	233
85	0

Cone of Light Footcandles			
Distance to Illuminated Plane	Initial Nadir Footcandles	Beam (ft.)	
		L Length	W Width
5.5'	100.8	3.8	3.8
7'	62.2	5	5
8'	47.7	5.6	5.6
9'	37.7	6.4	6.4
10'	30.5	7.2	7.2
12'	21.2	8.6	8.6

Beam diameter is to 50% of maximum footcandles, rounded to the nearest half-foot. Footcandle values are initial, apply appropriate light loss factors where necessary.

Zonal Lumen Summary		
Zone	Lumens	% Fixture
0-30	1541	76.1
0-40	1920	94.9
0-60	2020	99.8
0-90	2024	100

PHOTOMETRY - 3000 lumen / 80 CRI

PD630D010B-PDM6B835-61VC

Spacing Criteria = 0.72
Lumens per Watt = 109.4 Lm/W
Test No. P215344
Test Model: PD630D010B-PDM6B835-61VC

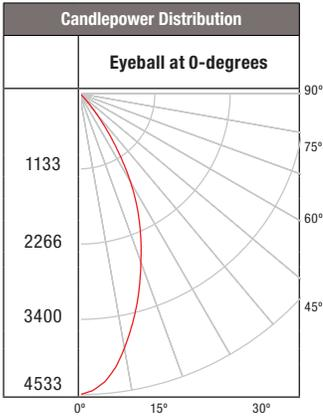

Candela Distribution	
Degrees Vertical	Candela
0*	4533
5	4358
10	3892
20	2700
30	1532
40	401
50	45
60	7
70	2
80	0
90	0

*CBCP

Luminance	
(Average Candela/M²)	
Degree	Avg. 0° Luminance
45	11350
55	1271
65	428
75	360
85	0

Cone of Light Footcandles			
Distance to Illuminated Plane	Initial Nadir Footcandles	Beam (ft.)	
		L Length	W Width
5.5'	149.8	3.8	3.8
7'	92.5	5	5
8'	70.8	5.6	5.6
9'	56	6.4	6.4
10'	45.3	7.2	7.2
12'	31.5	8.6	8.6

Beam diameter is to 50% of maximum footcandles, rounded to the nearest half-foot. Footcandle values are initial, apply appropriate light loss factors where necessary.

Zonal Lumen Summary		
Zone	Lumens	% Fixture
0-30	2290	76.1
0-40	2854	94.9
0-60	3002	99.8
0-90	3008	100

PHOTOMETRY - 3000 lumen / 90 CRI

PD630D010B-PDM6B935-61VC

Spacing Criteria = 0.72
Lumens per Watt = 95.9 Lm/W
Test No. P215348
Test Model: PD630D010B-PDM6B935-61VC

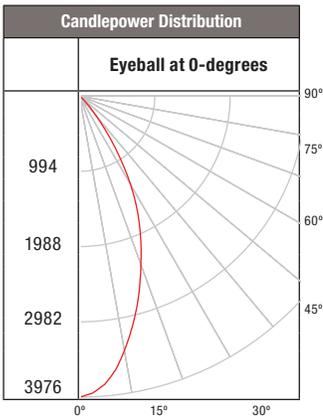

Candela Distribution	
Degrees Vertical	Candela
0*	3976
5	3823
10	3415
20	2368
30	1344
40	352
50	39
60	6
70	2
80	0
90	0

*CBCP

Luminance	
(Average Candela/M²)	
Degree	Avg. 0° Luminance
45	9955
55	1118
65	376
75	318
85	0

Cone of Light Footcandles			
Distance to Illuminated Plane	Initial Nadir Footcandles	Beam (ft.)	
		L Length	W Width
5.5'	131.5	3.8	3.8
7'	81.2	5	5
8'	62.1	5.6	5.6
9'	49.1	6.4	6.4
10'	39.8	7.2	7.2
12'	27.6	8.6	8.6

Beam diameter is to 50% of maximum footcandles, rounded to the nearest half-foot. Footcandle values are initial, apply appropriate light loss factors where necessary.

Zonal Lumen Summary		
Zone	Lumens	% Fixture
0-30	2009	76.1
0-40	2504	94.9
0-60	2634	99.8
0-90	2639	100