

Project:	Catalog No: PLD480WH	Mfg:
Location:	Fixture Type:	Qty:
Notes:		Lamps:

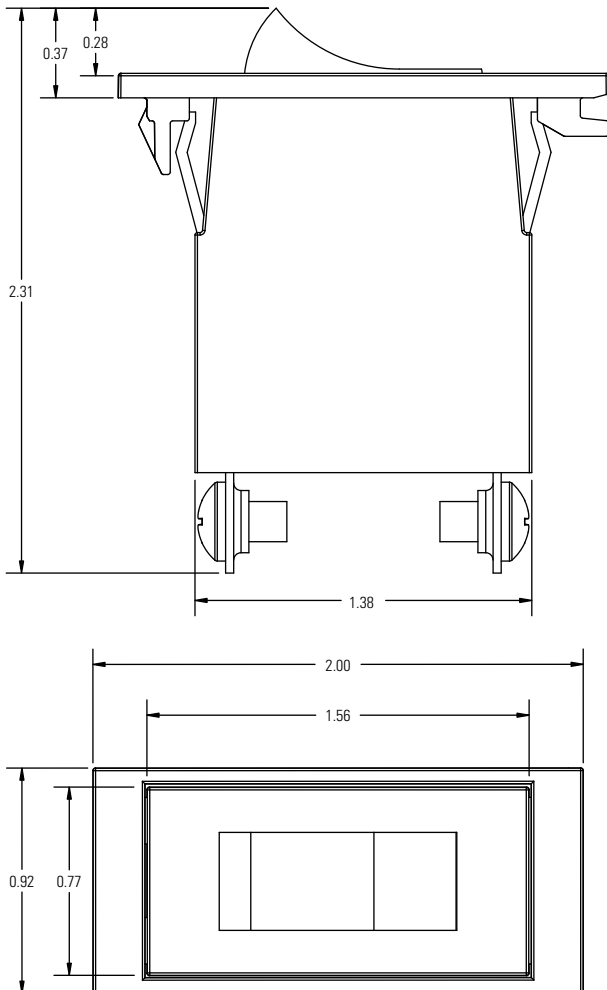

Catalog Number	Finish	Rating	Mounting	Compatible Connector Kits
PLD120BK	Black	120W, 1.0A	Snaps in directly to any compatible PowerTrip Connector Kit	9099WH, 9099BK 9033WH, 9033BK 6099WH, 6099BK 6033WH, 6033BK 6199WH, 6199BK 6133WH, 6133BK
PLD120WH	White			
PLD240BK	Black	240W, 2.0A		
PLD240WH	White			
PLD300BK	Black	300W, 2.5A		
PLD300WH	White			
PLD360BK	Black	360W, 3.0A		
PLD360WH	White			
PLD480BK	Black	480W, 4.0A		
PLD480WH	White			
PLD600BK	Black	600W, 5.0A		
PLD600WH	White			
PLD720BK	Black	720W, 6.0A		
PLD720WH	White			
PLD840BK	Black	840W, 7.0A		
PLD840WH	White			
PLD900BK	Black	900W, 7.5A		
PLD900WH	White			
PLD960BK	Black	960W, 8.0A		
PLD960WH	White			
PLD1080BK	Black	1080W, 9.0A		
PLD1080WH	White			
PLD1200BK	Black	1200W, 10.0A		
PLD1200WH	White			
PLD1320BK	Black	1320W, 11.0A		
PLD1320WH	White			
PLD1440BK	Black	1440W, 12.0A		
PLD1440WH	White			

Features

- Wire Terminals:** #8 screws for 12 or 14 ga. solid copper wires.
- Reset Rocker:** Easy switch like breaker re-set actuator with ON/OFF markings. Red color indicates OFF position. Can be used as standard ON/OFF switch
- Panel Mount:** Breaker snaps into PowerTrip track connector without the use of tools.

Electrical

Capacity is 120 volts, 60Hz. All Lytespan Track luminaires are polarized and continuously grounded throughout. Electrical conductors are concealed in an insulating liner. Intended for wiring to branch circuit building wire with ground. All wiring must be in accordance with National and Local Codes.

Short Circuit Current Rating (AIC): 1kA

Use 90° C minimum supply wire.

Labels

cULus listed.