

## DESCRIPTION

Cruze LED is a premium grade specification lensed troffer series. This innovative, high quality luminaire is dedicated to the latest solid state lighting and driver technology for optimal performance and energy efficiency. The Cruze is compatible with all of today's popular ceiling systems and is available with a number of options and accessories for application versatility.

The Cruze series features efficiency, quality and performance. The series is an excellent choice for commercial office spaces, schools, hospitals or retail merchandising areas.

## SPECIFICATION FEATURES

### Construction

Rigid housing is die formed of code gauge prime cold rolled steel and features full length die-formed stiffeners and unibody endplate for added strength. Side flanges are hemmed. Innovative design provides superior lens brightness uniformity and visual comfort. Unibody endplates are securely attached with interlocking tabs and screws. Four auxiliary fixture end suspension points provided.

### Controls

The Cruze LED is Powered by Fifth Light, with a standard 0-10V continuous dimming driver that works with any 0-10V control/dimmer. Combine with energy saving products like occupancy sensors, daylighting controls and lighting relay panels to maximize energy savings. In addition, the Cruze can include a factory-installed integrated sensor system for occupancy and daylight dimming control and manual control from an optional handheld remote. Or, specify the Digital Addressable Lighting Interface (DALI) drivers, dimmable down to 10%, for use with Fifth Light controls. See ordering information for details on all three options.

### Electrical

Long-Life LED system coupled with electrical driver to deliver optimal performance. LED's available in 3000K, 3500K, 4000K or 5000K with a typical CRI  $\leq 85$ . Projected life is 60,000 hours at 79% lumen output. cULus listed. Electronic drivers are available for 120-277V and 347V applications.

### Emergency Battery Pack Option

Optional 120v-277v integral emergency battery pack is available in 7-watts or 14-watts to meet critical life-safety lighting requirements. The 90-minute batteries provide constant power to the LED system, ensuring code-compliance. A test switch/indicator button can be tested safely from the ground using a laser pointer, while the patented EZ Key prevents accidental discharge of the battery during construction. See ordering information for details.

### Finish

Multistage, iron phosphate pretreatment ensures maximum bonding and rust inhibition. Housing finished with 90% reflective white enamel for superior performance.

Catalog #		Type
Project		
Comments		Date
Prepared by		

### Hinging/Latching

Positive cam action steel latches with baked white enamel finish. Safety-lock T-hinges allow hinging and latching either side. Door assembly hinges down for easy access from below.

### Frame/Shielding

Die formed, heavy gauge, flat steel door with reinforced mitered corners and painted after fabrication, baked matte white enamel finish. Positive light seals. Acrylic frosted lens.

### Compliance

Modules are UL recognized components and indoor luminaires are cULus listed for 25°C ambient environments, RoHS compliant, and LED modules comply with IESNA LM-79 and LM-80 standards. DesignLights Consortium® Qualified and classified for both DLC Standard and DLC Premium, refer to [www.designlights.org](http://www.designlights.org) for details.

### Warranty

Five year warranty.



**22CZ**  
**LED**

**2' X 2' TROFFER LED**  
**MODULE**

Specification Grade Troffer

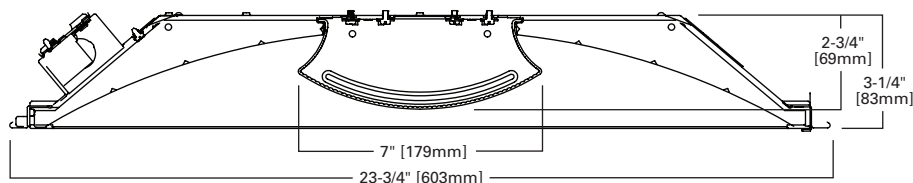

## MOUNTING DATA

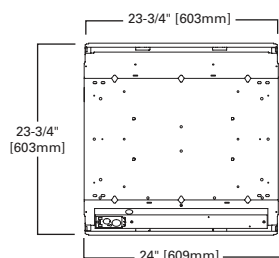

## LAMP CONFIGURATIONS

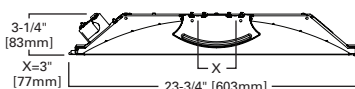

## CEILING COMPATIBILITY

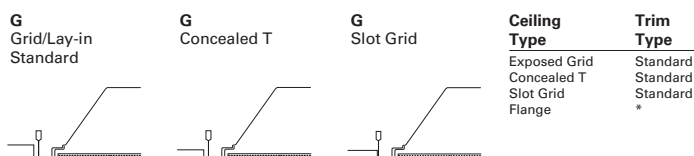

## CERTIFICATION DATA

cULus - 1598  
 Damp Location Listed  
 IC Rated  
 LM79/LM80 Compliant  
 ROHS Compliant  
 DesignLights Consortium® Qualified  
 NOM Compliant

\*See Drywall Frame Kit Accessory in Ordering Information Section

**LINEAR DISCONNECT**

Safe and convenient means of disconnecting power



PHOTOMETRICS

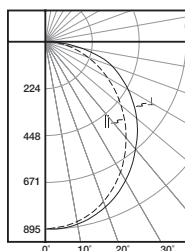

**22CZ-LD5-24-UNV-L835-CD1-U**

Electronic Driver  
 Linear LED 3500K  
 Spacing criterion:  
 (II) 1.17 x mounting  
 height, (⊥) 1.25 x  
 mounting height  
 Lumens: 2470  
 Input Watts: 19.6W  
 Efficacy: 126.0 lm/W  
 Test Report:  
 22CZ-LD5-24-UNV-  
 L835-CD1-U.IES

**Candlepower**

Angle	Along II	45°	Across ⊥
0	893	893	893
5	884	890	892
10	866	875	879
15	838	849	857
20	799	815	829
25	753	774	793
30	701	725	750
35	641	670	703
40	577	611	651
45	511	551	602
50	445	492	548
55	379	432	490
60	313	372	434
65	249	311	374
70	186	251	315
75	126	193	231
80	74	122	140
85	30	47	46
90	0	0	0

**Coefficients of Utilization**

rc rw RCR	Effective floor cavity reflectance																							
	80%				70%				50%				30%				10%				0%			
	70	50	30	10	70	50	30	10	50	30	10	50	30	10	50	30	10	50	30	10	50	30	10	
0	119	119	119	119	116	116	116	116	111	111	111	106	106	106	102	102	102	100	100	100	100	100	100	
1	108	104	99	95	106	101	97	94	97	94	91	93	90	88	89	87	85	83	83	83	83	83	83	
2	98	90	83	77	96	88	82	76	85	79	74	81	77	73	78	74	71	69	69	69	69	69	69	
3	90	79	71	64	87	77	70	63	74	68	62	72	66	61	69	64	60	58	58	58	58	58	58	
4	82	70	61	54	80	69	60	54	66	59	53	64	57	52	62	56	52	49	49	49	49	49	49	
5	75	62	53	47	73	61	53	46	59	52	46	57	51	45	55	50	45	43	43	43	43	43	43	
6	70	56	47	41	68	55	47	41	53	46	40	52	45	40	50	44	39	37	37	37	37	37	37	
7	65	51	42	36	63	50	42	36	49	41	36	47	40	35	46	40	35	33	33	33	33	33	33	
8	60	47	38	32	59	46	38	32	45	37	32	43	37	32	42	36	31	30	30	30	30	30	30	
9	56	43	35	29	55	42	34	29	41	34	29	40	33	29	39	33	28	27	27	27	27	27	27	
10	53	40	32	26	52	39	31	26	38	31	26	37	31	26	36	30	26	24	24	24	24	24	24	

**Zonal Lumen Summary**

Zone	Lumens	% Fixture
0-30	680	27.5
0-40	1099	44.5
0-60	1915	77.5
0-90	2470	100.0
0-180	2470	100.0

**Luminance Data**

Angle in Deg	Average 0-Deg cd/sm	Average 45-Deg cd/sm	Average 90-Deg cd/sm
45	2314	2495	2726
55	2116	2412	2736
65	1887	2357	2834
75	1559	2388	2858
85	1102	1727	1690

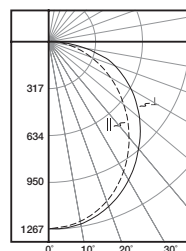

**22CZ-LD5-34-UNV-L835-CD1-U**

Electronic Driver  
 Linear LED 3500K  
 Spacing criterion:  
 (II) 1.17 x mounting  
 height, (⊥) 1.25 x  
 mounting height  
 Lumens: 3497  
 Input Watts: 29.4W  
 Efficacy: 118.9 lm/W  
 Test Report:  
 22CZ-LD5-34-UNV-  
 L835-CD1-U.IES

**Candlepower**

Angle	Along II	45°	Across ⊥
0	1264	1264	1264
5	1252	1260	1263
10	1226	1239	1246
15	1186	1202	1215
20	1133	1154	1173
25	1066	1095	1122
30	991	1026	1061
35	906	949	995
40	816	866	922
45	726	782	851
50	630	697	776
55	537	612	696
60	443	527	614
65	351	439	529
70	262	356	445
75	178	273	322
80	102	170	198
85	42	67	64
90	0	0	0

**Coefficients of Utilization**

rc rw RCR	Effective floor cavity reflectance																							
	80%				70%				50%				30%				10%				0%			
	70	50	30	10	70	50	30	10	50	30	10	50	30	10	50	30	10	50	30	10	50	30	10	
0	119	119	119	119	116	116	116	116	111	111	111	106	106	106	102	102	102	100	100	100	100	100	100	
1	108	104	99	95	106	101	97	94	97	94	91	93	90	88	89	87	85	83	83	83	83	83	83	
2	98	90	83	77	96	88	82	76	85	79	74	81	77	73	78	74	71	69	69	69	69	69	69	
3	90	79	71	64	87	77	70	63	74	68	62	72	66	61	69	64	60	58	58	58	58	58	58	
4	82	70	61	54	80	69	60	54	66	59	53	64	57	52	62	56	52	49	49	49	49	49	49	
5	75	62	53	47	73	61	53	46	59	52	46	57	51	45	55	50	45	43	43	43	43	43	43	
6	70	56	47	41	68	55	47	41	53	46	40	52	45	40	50	44	39	37	37	37	37	37	37	
7	65	51	42	36	63	50	42	36	49	41	36	47	40	35	46	40	35	33	33	33	33	33	33	
8	60	47	38	32	59	46	38	32	45	37	32	43	37	32	42	36	31	30	30	30	30	30	30	
9	56	43	35	29	55	42	34	29	41	34	29	40	33	29	39	33	28	27	27	27	27	27	27	
10	53	40	32	26	52	39	31	26	38	31	26	37	31	26	36	30	26	24	24	24	24	24	24	

**Zonal Lumen Summary**

Zone	Lumens	% Fixture
0-30	962	27.5
0-40	1557	44.5
0-60	2711	77.5
0-90	3497	100.0
0-180	3497	100.0

**Luminance Data**

Angle in Deg	Average 0-Deg cd/sm	Average 45-Deg cd/sm	Average 90-Deg cd/sm
45	3288	3542	3854
55	2998	3417	3886
65	2660	3327	4009
75	2202	3378	3984
85	1543	2462	2352

Stock or MTO*	Catalog Logic (Ribbed Lens)	Delivered Lumens	Watts	Efficacy (lm/W)
MTO	22CZ-LD5-20-UNV-L830-CD1-U	1964	16.4	120
MTO	22CZ-LD5-20-UNV-L835-CD1-U	2086	16.4	127
MTO	22CZ-LD5-20-UNV-L840-CD1-U	2128	16.4	130
MTO	22CZ-LD5-20-UNV-L850-CD1-U	2302	16.4	141
MTO	22CZ-LD5-24-UNV-L830-CD1-U	2325	19.6	119
Stock	22CZ-LD5-24-UNV-L835-CD1-U	2470	19.6	126
Stock	22CZ-LD5-24-UNV-L840-CD1-U	2519	19.6	128
MTO	22CZ-LD5-24-UNV-L850-CD1-U	2725	19.6	139
MTO	22CZ-LD5-29-UNV-L830-CD1-U	2729	23.5	116
MTO	22CZ-LD5-29-UNV-L835-CD1-U	2899	23.5	123
MTO	22CZ-LD5-29-UNV-L840-CD1-U	2957	23.5	126
MTO	22CZ-LD5-29-UNV-L850-CD1-U	3199	23.5	136
MTO	22CZ-LD5-34-UNV-L830-CD1-U	3292	29.4	112
Stock	22CZ-LD5-34-UNV-L835-CD1-U	3497	29.4	119
Stock	22CZ-LD5-34-UNV-L840-CD1-U	3567	29.4	121
MTO	22CZ-LD5-34-UNV-L850-CD1-U	3858	29.4	131
MTO	22CZ-LD5-39-UNV-L830-CD1-U	3701	36.4	102
MTO	22CZ-LD5-39-UNV-L835-CD1-U	3932	36.4	108
MTO	22CZ-LD5-39-UNV-L840-CD1-U	4011	36.4	110
MTO	22CZ-LD5-39-UNV-L850-CD1-U	4338	36.4	119
MTO	22CZ-LD5-44-UNV-L830-CD1-U	4173	41.8	100
MTO	22CZ-LD5-44-UNV-L835-CD1-U	4433	41.8	106
MTO	22CZ-LD5-44-UNV-L840-CD1-U	4522	41.8	108
MTO	22CZ-LD5-44-UNV-L850-CD1-U	4891	41.8	117

\*Made to order (MTO) requires a typical three week lead time.

Stock or MTO*	Catalog Logic (Smooth Lens)	Delivered Lumens	Watts	Efficacy (lm/W)
MTO	22CZ-LD5-20-S-UNV-L830-CD1-U	2003	16.4	122
MTO	22CZ-LD5-20-S-UNV-L835-CD1-U	2128	16.4	130
MTO	22CZ-LD5-20-S-UNV-L840-CD1-U	2170	16.4	132
MTO	22CZ-LD5-20-S-UNV-L850-CD1-U	2348	16.4	143
MTO	22CZ-LD5-24-S-UNV-L830-CD1-U	2372	19.6	121
MTO	22CZ-LD5-24-S-UNV-L835-CD1-U	2519	19.6	128
MTO	22CZ-LD5-24-S-UNV-L840-CD1-U	2570	19.6	131
MTO	22CZ-LD5-24-S-UNV-L850-CD1-U	2780	19.6	142
MTO	22CZ-LD5-29-S-UNV-L830-CD1-U	2784	23.5	118
MTO	22CZ-LD5-29-S-UNV-L835-CD1-U	2957	23.5	126
MTO	22CZ-LD5-29-S-UNV-L840-CD1-U	3016	23.5	128
MTO	22CZ-LD5-29-S-UNV-L850-CD1-U	3263	23.5	139
MTO	22CZ-LD5-34-S-UNV-L830-CD1-U	3358	29.4	114
MTO	22CZ-LD5-34-S-UNV-L835-CD1-U	3567	29.4	121
MTO	22CZ-LD5-34-S-UNV-L840-CD1-U	3638	29.4	124
MTO	22CZ-LD5-34-S-UNV-L850-CD1-U	3936	29.4	134
MTO	22CZ-LD5-39-S-UNV-L830-CD1-U	3775	36.4	104
MTO	22CZ-LD5-39-S-UNV-L835-CD1-U	4011	36.4	110
MTO	22CZ-LD5-39-S-UNV-L840-CD1-U	4091	36.4	112
MTO	22CZ-LD5-39-S-UNV-L850-CD1-U	4425	36.4	122
MTO	22CZ-LD5-44-S-UNV-L830-CD1-U	4256	41.8	102
MTO	22CZ-LD5-44-S-UNV-L835-CD1-U	4522	41.8	108
MTO	22CZ-LD5-44-S-UNV-L840-CD1-U	4612	41.8	110
MTO	22CZ-LD5-44-S-UNV-L850-CD1-U	4989	41.8	119

\*Made to order (MTO) requires a typical three week lead time.

## Standard Efficacy Versions

Stock or MTO*	Catalog Logic (Ribbed Lens)	Delivered Lumens	Watts	Efficacy (lm/W)
MTO	22CZ-LD5-20SE-UNV-L830-CD1-U	1948	17.2	113
STOCK	22CZ-LD5-20SE-UNV-L835-CD1-U	2069	17.2	120
STOCK	22CZ-LD5-20SE-UNV-L840-CD1-U	2110	17.2	123
MTO	22CZ-LD5-20SE-UNV-L850-CD1-U	2283	17.2	133
MTO	22CZ-LD5-24SE-UNV-L830-CD1-U	2322	21.1	110
STOCK	22CZ-LD5-24SE-UNV-L835-CD1-U	2467	21.1	117
STOCK	22CZ-LD5-24SE-UNV-L840-CD1-U	2516	21.1	119
MTO	22CZ-LD5-24SE-UNV-L850-CD1-U	2722	21.1	129
MTO	22CZ-LD5-32SE-UNV-L830-CD1-U	3015	30.5	99
STOCK	22CZ-LD5-32SE-UNV-L835-CD1-U	3203	30.5	105
STOCK	22CZ-LD5-32SE-UNV-L840-CD1-U	3267	30.5	107
MTO	22CZ-LD5-32SE-UNV-L850-CD1-U	3534	30.5	116
MTO	22CZ-LD5-39SE-UNV-L830-CD1-U	3728	34.9	107
STOCK	22CZ-LD5-39SE-UNV-L835-CD1-U	3960	34.9	114
STOCK	22CZ-LD5-39SE-UNV-L840-CD1-U	4039	34.9	116
MTO	22CZ-LD5-39SE-UNV-L850-CD1-U	4369	34.9	125
MTO	22CZ-LD5-44SE-UNV-L830-CD1-U	4118	40.0	103
STOCK	22CZ-LD5-44SE-UNV-L835-CD1-U	4375	40.0	109
STOCK	22CZ-LD5-44SE-UNV-L840-CD1-U	4463	40.0	112
MTO	22CZ-LD5-44SE-UNV-L850-CD1-U	4827	40.0	121

\*Made to order (MTO) requires a typical three week lead time.

## Standard Efficacy Versions

Stock or MTO*	Catalog Logic (Smooth Lens)	Delivered Lumens	Watts	Efficacy (lm/W)
MTO	22CZ-LD5-20SE-S-UNV-L830-CD1-U	1987	17.2	115
MTO	22CZ-LD5-20SE-S-UNV-L835-CD1-U	2110	17.2	123
MTO	22CZ-LD5-20SE-S-UNV-L840-CD1-U	2153	17.2	125
MTO	22CZ-LD5-20SE-S-UNV-L850-CD1-U	2328	17.2	135
MTO	22CZ-LD5-24SE-S-UNV-L830-CD1-U	2369	21.1	112
MTO	22CZ-LD5-24SE-S-UNV-L835-CD1-U	2516	21.1	119
MTO	22CZ-LD5-24SE-S-UNV-L840-CD1-U	2567	21.1	122
MTO	22CZ-LD5-24SE-S-UNV-L850-CD1-U	2776	21.1	132
MTO	22CZ-LD5-32SE-S-UNV-L830-CD1-U	3075	30.5	101
MTO	22CZ-LD5-32SE-S-UNV-L835-CD1-U	3267	30.5	107
MTO	22CZ-LD5-32SE-S-UNV-L840-CD1-U	3332	30.5	109
MTO	22CZ-LD5-32SE-S-UNV-L850-CD1-U	3605	30.5	118
MTO	22CZ-LD5-39SE-S-UNV-L830-CD1-U	3802	34.9	109
MTO	22CZ-LD5-39SE-S-UNV-L835-CD1-U	4039	34.9	116
MTO	22CZ-LD5-39SE-S-UNV-L840-CD1-U	4120	34.9	118
MTO	22CZ-LD5-39SE-S-UNV-L850-CD1-U	4457	34.9	128
MTO	22CZ-LD5-44SE-S-UNV-L830-CD1-U	4201	40.0	105
MTO	22CZ-LD5-44SE-S-UNV-L835-CD1-U	4463	40.0	112
MTO	22CZ-LD5-44SE-S-UNV-L840-CD1-U	4552	40.0	114
MTO	22CZ-LD5-44SE-S-UNV-L850-CD1-U	4924	40.0	123

\*Made to order (MTO) requires a typical three week lead time.

LUMEN MAINTENANCE

Ambient Temperature	TM-21 Lumen Maintenance (60,000 hours)	Theoretical L70 (Hours)
25°C	> 79%	> 178,000

90 CRI

Lumen Adjustment Factors 80->90 CRI	
3000K	0.88
3500K	0.861
4000K	0.865
5000K	0.87

Example of Lumen Adjustment Calculation

22CZ-LD5-34-UNV-L935-CD1-U  
at 90CRI at 3500K

Lumen Adjustment Factor = 0.861

Total Light Output =  
3,497 lm x 0.861 = 3,010 lm

Efficacy =  $\frac{3,010 \text{ lm}}{29.4 \text{ W}} = 102.3 \text{ lm/W}$

ORDERING INFORMATION

SAMPLE NUMBER: 22CZ-LD5-34-UNV-L835-CD1-U

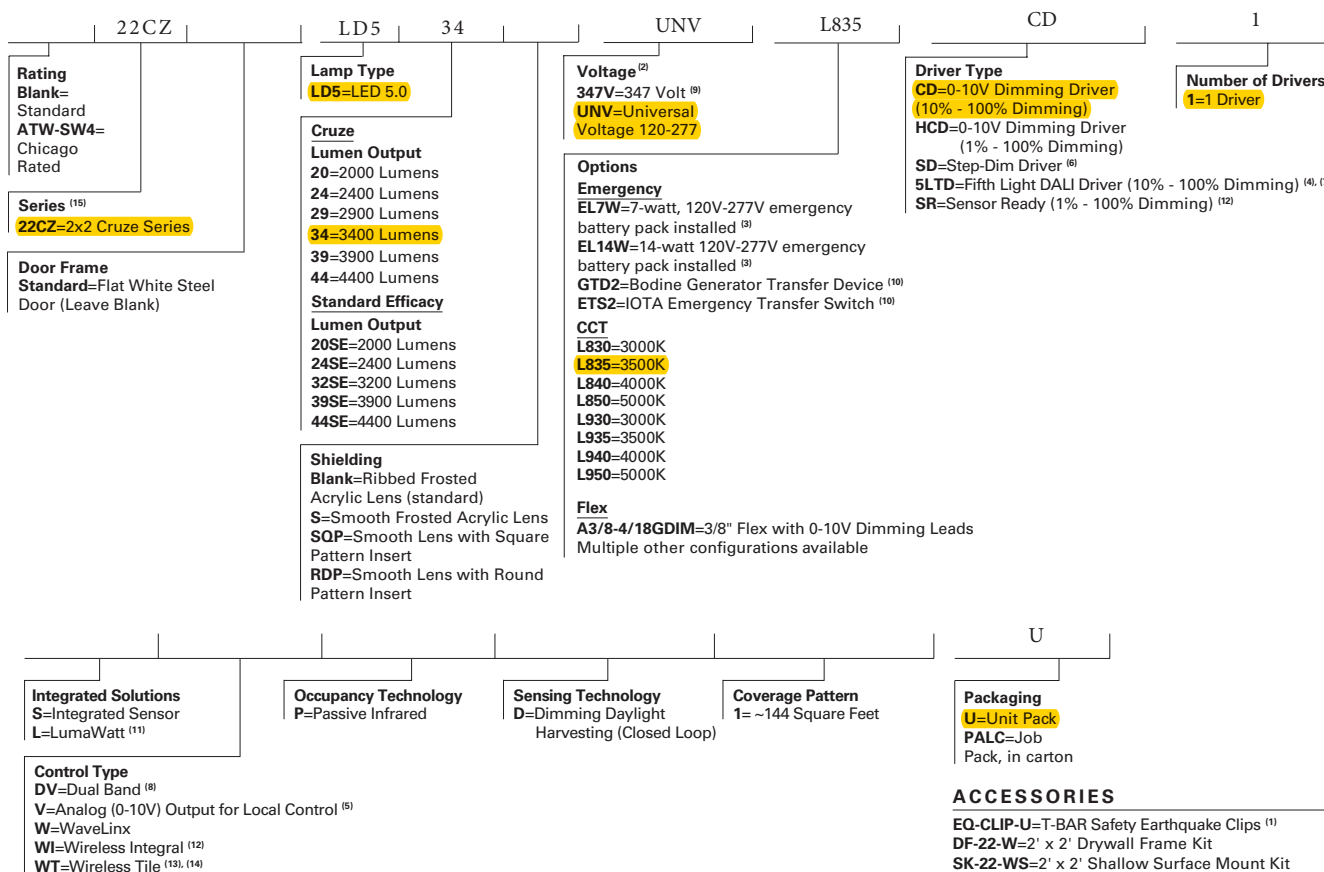

ACCESSORIES

- EQ-CLIP-U=T-BAR Safety Earthquake Clips
- DF-22-W=2' x 2' Drywall Frame Kit
- SK-22-WS=2' x 2' Shallow Surface Mount Kit
- SK-22-WT=2' x 2' Tall Surface Mount Kit
- DF10P-C=Decorator Dimmer, 0-10V
- SF10P\_=Decorator Slide Dimmer, 0-10V
- ISHH-01=Programming Remote for Integrated Sensor
- ISHH-02=Personal Control Remote for Integrated Sensor

NOTES: (1)An EQ Grid Clip is recommended for all 9/16" ceiling systems. Four required per fixture. (2)Products also available in non-US voltages and frequencies for international markets. (3)With integral test switch/indicator/laser test. For approximate delivered lumens multiply the lumens per watt of the desired fixture by the wattage of the emergency battery pack (100 lm/W x 7=700 lumens). IES-format photometry for luminaire under emergency operation available. (4)Must be used in conjunction with a DALI control system. For a complete listing of Fifth Light Technology products and other solutions from Cooper Controls, visit www.eaton.com/lightingsystems. (5)Integral sensor works with CD and HCD drivers and is factory prewired to the driver for stand-alone control. (6)Step dim driver option is not available with 2000, 2400, 2900 and 3400 lumen packages and 2000SE, 2400SE and 3200SE versions. (7)Fifth Light (5LTD) driver option is not available with 2000, 2400, 2900 and 3400 lumen packages and 2000SE, 2400SE and 3200SE versions. (8)Provides blank band on opposite side from sensor band to provide symmetric appearance. (9)347V versions are not available with emergency options. SD, 5LTD, and SR drivers with 347V are available but not DLC qualified. (10)Used to transfer fixture to secondary power source for life-safety operation. When used with a dimming fixture, two devices are required to ensure control is disabled while operating under emergency power. (11)Must be used in conjunction with a LumaWatt Pro control system. For complete LumaWatt Pro wireless solutions, visit www.eaton.com/lumawattpro. (12)SR driver compatible with LWI option only. (13)LWT compatible with CD and HCD drivers only. (14)LWT sensor is external to luminaire, cable factory wired. (15)DesignLights Consortium® Qualified and classified for both DLC Standard and DLC Premium, refer to www.designlights.org for details.

Specifications & dimensions subject to change without notice. Consult your Eaton Representative for availability and ordering information.

SHIPPING DATA

Catalog No.	Wt.
22CZ-LD5-27	12.5 lbs.
22CZ-LD5-36	12.5 lbs.



Eaton  
1121 Highway 74 South  
Peachtree City, GA 30269  
P: 770-486-4800  
www.eaton.com/lighting

Specifications and dimensions subject to change without notice.

PS519141EN  
10-9-2017

**INTEGRATED SENSOR**

The Cruze with Integrated Sensor technology provides automatic energy savings without sacrificing performance. Traditionally, these types of energy savings required coordination between the luminaire and a lighting control system. The Cruze delivers superior lighting with integrated occupancy and daylighting controls.

Capture the benefits of traditional lighting controls, without complicated coverage planning or special wiring. Ideal for new construction or retrofit, the Cruze delivers automatic ON to an energy saving light level, while ensuring lighting is turned OFF when the space is unoccupied.

The integral daylight sensor reduces the need for special daylight zone planning. Each luminaire will automatically adjust the light level based on reflected light beneath the sensor in a closed loop method.

Occupied daylight light levels and unoccupied light levels can be adjusted using the integrated sensor programming remote (Catalog Number: ISHH-01). The integrated sensor personal remote (Catalog Number: ISHH-02) provides code compliant manual raise, lower, ON, OFF control.

The Cruze with Integrated Sensor is easy to install with no special wiring and ensures energy savings out-of-the-box with default control settings.

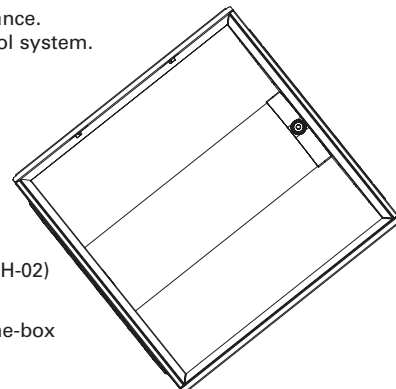

**How it works:**

- As the user enters the space controlled by the integral sensor, the lighting turns ON to the default daylight level.
- Lighting will remain at that the daylight level until the space is unoccupied. This will start the occupancy timeout period (default 20 minutes).
- If the space remains unoccupied for half of the timeout period, the lighting will automatically reduce to the Energy Saver light level. This adjustable light level is typically half of the occupied daylight level.
- At the end of the timeout period the lighting will go to the unoccupied light level. This adjustable light level uses the OFF default setting.

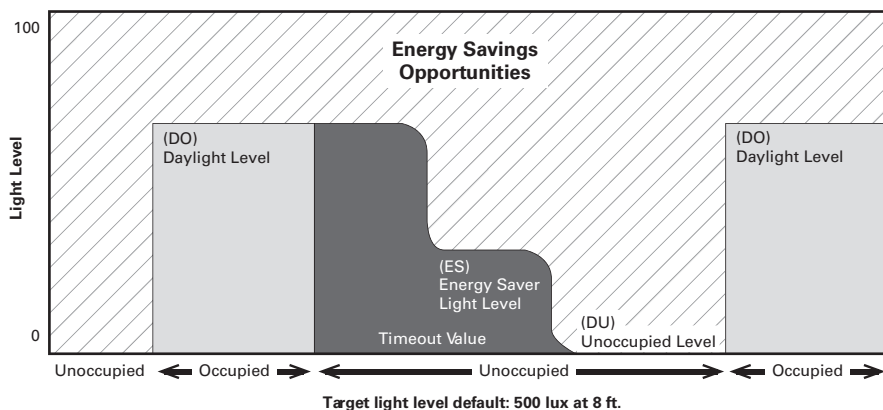

**Coverage**

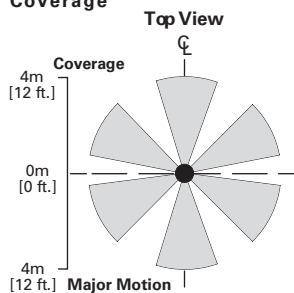

**Side View**

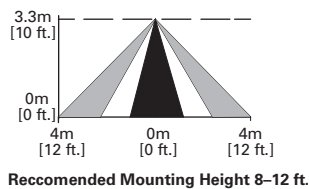

**Optional Remote Controls**



**ISHH-01 Programming Remote**



**ISHH-02 Personal Control Remote**