

Project		Catalog #		Type	
Prepared by		Notes		Date	



Metalux

OHB LED Standard Efficacy

LED High Bay Efficiency Luminaire

Typical Applications

Industrial • Commercial • Manufacturing • Food Processing • Sports / Multi-Purpose

Interactive Menu

- Order Information [page 2](#)
- Photometric Data [page 3](#)
- Connected Systems [page 5](#)
- Product Warranty

Product Certification



Product Features



Top Product Features

- Precision designed optical performance
- Offered in both standard and high efficacy versions
- High performance efficacy up to 210 lm/W
- Efficient 1-for-1 replacement of linear fluorescent & HID fixtures
- Lumen packages – 12K, 15K, 18K, 24K, 30K, 36K, 48K, 60K
- Narrow, medium, and wide distribution

Dimensional and Mounting Details

OHB-12SE, 15SE

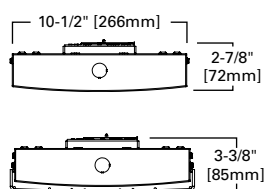

OHB-18SE, 24SE, 30SE

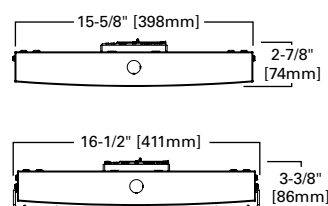

OHB-36SE, 48SE, 60SE

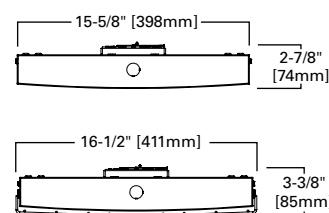

[additional product diagrams](#)

Order Information

SAMPLE ORDER NUMBER: **OHB-24SE-MFL-UNV-L840-CD-U** Includes V Hangers for rapid installation

Series	Revision	Lumen Packages/ Standard Efficacy	Distribution/Shielding	Voltage	CCT/CRI
Series ⁽¹⁶⁾	Revision	Lumen Packages / Standard Efficacy	Distribution/Shielding	Voltage ^{(1), (2), (13)}	CCT/CRI
OHB-Optimized High Bay	[Blank]	12SE=12,000 Lumens 15SE=15,000 Lumens 18SE=18,000 Lumens 24SE=24,000 Lumens 30SE=30,000 Lumens 36SE=36,000 Lumens 48SE=48,000 Lumens 60SE=60,000 Lumens	N=Narrow MFL=Medium Frosted MCL=Medium Clear W=Wide NL=No Lens ⁽¹⁵⁾	120V=120 Volt 277V=277 Volt 347V=347 Volt 480V=480 Volt UNV=Universal Voltage 120-277 UNC=Universal Voltage 347/480	L730=70CRI / 3000K L735=70CRI / 3500K L740=70CRI / 4000K L750=70CRI / 5000K L830=80CRI / 3000K L835=80CRI / 3500K L840=80CRI / 4000K L850=80CRI / 5000K L930=90CRI / 3000K L935=90CRI / 3500K L940=90CRI / 4000K L950=90CRI / 5000K
Notes			Notes	Notes	
(16) DesignLights Consortium® Qualified and classified for both DLC Standard and DLC Premium, refer to www.designlights.org for details.			(15) (NL) Non lens version not available with 36SE, 48SE, and 60SE lumen packages.	(1) Voltage must be specified when ordered with plugs or emergency drivers. (2) When ordering sensor or EBP/TD option, specify as UNV (for 120V or 277V), 347V or 480V. (13) Ambient temperatures limited to 40C when using emergency, sensors, or SLTD in conjunction with 347V or 480V.	

Options	Driver Type	Wiring	Options	Packaging
Options	Driver Type	Wiring	Options	Packaging
EBP/TD EL20W=20-watt 120V-277V emergency battery pack installed ^{(4), (5), (8), (12), (13)} EL20-W-REM=20-watt 120V-277V emergency battery pack remote mounted ^{(4), (5), (12), (13)} GTR2=Bodine Generator Transfer Device ⁽⁷⁾ ETRD=lota Emergency Transfer Relay with dimming control ^{(6), (8)}	CD=0-10V Dimming Driver 5LTD=Fifth Light DALI ⁽¹⁴⁾	C3 (1)=1 Circuit, 3' Cord with no Plug C3 (2)=2 Circuits, 3' Cord with no Plug C6 (1)=1 Circuit, 6' Cord with no Plug C6 (2)=2 Circuits, 6' Cord with no Plug PC3/120=(NEMA L5-15P) 3' Cord with NEMA Plug PC3/277=(NEMA L7-15P) 3' Cord with NEMA Plug PC3/347=(NEMA L24-20P) 3' Cord with NEMA Plug PC3/480=(NEMA L8-20P) 3' Cord with NEMA Plug PC6/120=(NEMA L5-15P) 6' Cord with NEMA Plug PC6/277=(NEMA L7-15P) 6' Cord with NEMA Plug PC6/347=(NEMA L24-20P) 6' Cord with NEMA Plug PC6/480=(NEMA L8-20P) 6' Cord with NEMA Plug MW27DS16-4G06-M02=277V Drop SO Cord 4 Conductor & Ground, 6' Cable CUTSHEET BELOW	MP=Modular Plug ⁽³⁾ PAF=Painted After Fabrication HA=High Ambient ⁽⁹⁾ Motion Sensors MS=360° or 180° Motion Sensor Installed, (specify voltage) ⁽²⁾ SVPD3=Integrated occupancy and daylight dimming sensor, 1200 sq. ft. coverage LWR=LumaWatt Wireless Sensor system ZW-SWPD3=Integrated Wavelinx Wireless Sensor, 1200 sq ft. coverage ZW=Wavelinx Wireless Ready (does not include sensor)	U=Unit Pack PALC=Job Pack, in carton
Notes	Notes		Notes	
(4) For approximate delivered lumens multiply the lumens per watt of the desired fixture by the wattage of the emergency battery pack. (5) EM options available in 0°C - 45°C ambient. (6) Used to transfer fixture to secondary power during outage. Must be used in conjunction with UL 1008 device (provided by others). These options require 2 relays on fixtures with dimming drivers. ETRD option only requires one relay when used on a dimming fixture. A maximum of two devices can be used on one product. (7) GRT2 option only available with 4ft fixture (36K, 48K, and 60K lumens). (8) OHB-SPM mounting not available with EL20W or ETRD options. (12) Refer to Ambient Chart for temperature ratings. (13) Ambient temperatures limited to 40C when using emergency, sensors, or SLTD in conjunction with 347V or 480V.	(14) Sensor or UNC not available in conjunction with 5LTD driver.		(2) When ordering sensor or EBP/TD option, specify as UNV (for 120V or 277V), 347V or 480V. (3) Requires use of MC or MPC cord accessories, specify voltage for plugs (MP). (9) High Ambient not available with integrated emergency.	

Accessories

Accessories (order separately)
OHB-WG112 =Wire guard for 12SE and 15SE OHB-WG162 =Wire guard for 18SE, 24SE, and 30SE OHB-WG164 =Wire guard for 36SE, 48SE, and 60SE Y-TOGGLE =Y Mounting Toggle, #2 Cable (Specify 10' or 30") FH-1 =Fixture Hook ⁽¹¹⁾ FL-1 =Fixture Loop ⁽¹¹⁾ OHB-SPM =Single Point Mounting Hub ⁽⁹⁾ MPC3 =3' Modular Power Cord & Plug (Specify Voltage) MPC6 =6' Modular Power Cord & Plug (Specify Voltage) MC3 =3' Modular Power Cord MC6 =6' Modular Power Cord SWPD3 =WaveLinX Wireless Sensor (to be installed with "ZW" sensor ready fixtures only)
Notes
(9) High Ambient not available with integrated emergency. (11) Must be used in conjunction with OHB-SPM accessory for proper installation.

Product Specifications

Construction

- Rugged and durable scalable design with rigid, steel center channel
- Mechanically attached end caps provide strength and durability
- Suspension mounting with optional wire hook and chain set or cable; Single monopoint mounting with SPM tong hanger

Electrical

- Long-Life LED system coupled with electrical driver for optimal performance
- LED's available in 3000K, 3500K, 4000K and 5000K with 70 CRI, 80 CRI and 90 CRI options
- Electronic drivers are available for 120-277V, 347V and 480V applications
- 0-10V dimming control (standard)
- Operating temperature of -40°C to 55°C (refer to chart)

Emergency Battery Pack Option

- 20-watt, 120-277V integral emergency battery pack available to meet critical life-safety lighting requirements
- 90-minute batteries provide constant power to the LED system, ensuring code-compliance
- Emergency/generator transfer options available (see ordering information for details)

Optics

- Precision designed optics deliver even illumination
- Offered in Narrow, medium and wide distributions

Shielding

- Standard lensing provides additional LED protection and optical control
- Optional wire guards available for more complex environments

Controls

- Integral occupancy sensor option provides 600 sq. ft. to up to 1250 sq. ft. of coverage in a maximum mounting height of 45' for occupancy sensing and daylight harvesting
- Integral 360° or 180° motion sensor
- LumaWatt wireless sensor system option
- Integrated Wavelinx Wireless Sensor option provides 1200 sq. ft. coverage
- WaveLinX wireless enabled (does not include sensor)

Finish

- White enamel finish preceded by a multistage cleaning cycle
- Iron phosphate coating with rust inhibitor protects against contaminants and oxidation

Compliance

- cULus listed for damp locations
- LED modules comply with IESNA LM-79 and LM-80 standards
- DesignLights Consortium® Qualified and classified for both DLC Standard and DLC Premium (refer to www.designlights.org for details)

Warranty

- Five year warranty standard.

Photometric Data

 [View IES files](#)

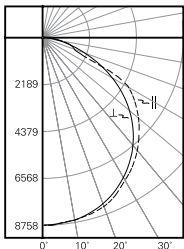

OHB-24SE-MCL-UNV-L850-CD-U
 Electronic Driver
 Linear LED 5000K
 Spacing criterion: (||) 1.3 x mounting height,
 (⊥) 1.27 x mounting height
 Lumens: 25295
 Input Watts: 148W
 Efficacy: 171 LPW
 Test Report: OHB-24SE-MCL-UNV-L850-CD-U.IES

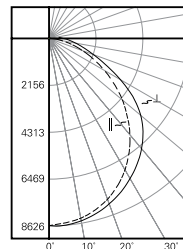

OHB-24SE-MFL-UNV-L850-CD-U
 Electronic Driver
 Linear LED 5000K
 Spacing criterion: (||) 1.2 x mounting height,
 (⊥) 1.28 x mounting height
 Lumens: 24524
 Input Watts: 148W
 Efficacy: 166 LPW
 Test Report: OHB-24SE-MFL-UNV-L850-CD-U.IES

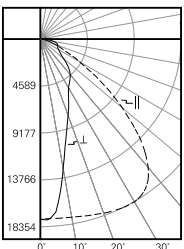

OHB-24SE-N-UNV-L850-CD-U
 Electronic Driver
 Linear LED 5000K
 Spacing criterion: (||) 1.51 x mounting height,
 (⊥) 0.53 x mounting height
 Lumens: 24662
 Input Watts: 148W
 Efficacy: 167 LPW
 Test Report: OHB-24SE-N-UNV-L850-CD-U.IES

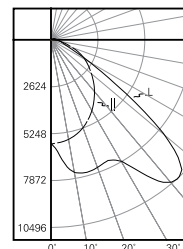

OHB-24SE-W-UNV-L850-CD-U
 Electronic Driver
 Linear LED 5000K
 Spacing criterion: (||) 1.16 x mounting height,
 (⊥) 2.19 x mounting height
 Lumens: 25020
 Input Watts: 148W
 Efficacy: 169 LPW
 Test Report: OHB-24SE-W-UNV-L850-CD-U.IES

Energy and Performance Data by Catalog Number

OHB - Standard Efficacy 5000K 70CRI											
Catalog Number	Lumen Output					Watts 277V	Efficacy (LPW)				
	N	MFL	MCL	W	NL		N	MFL	MCL	W	NL
OHB-12SE	13083	13009	13418	13272	13947	77	170	169	174	173	181
OHB-15SE	15964	15875	16374	16196	17019	98	163	162	167	166	174
OHB-18SE	20385	20270	20907	20680	21732	111	184	183	189	187	196
OHB-24SE	26200	26052	26872	26579	27931	148	177	176	182	180	189
OHB-30SE	31721	31543	32535	32181	33818	187	170	169	174	172	181
OHB-36SE	38724	38506	39717	39285	-	215	180	179	184	182	-
OHB-48SE	51180	50893	52493	51922	-	290	177	176	181	179	-
OHB-60SE	63442	63086	65069	64362	-	373	170	169	174	172	-

OHB - Standard Efficacy 5000K 80CRI											
Catalog Number	Lumen Output					Watts 277V	Efficacy (LPW)				
	N	MFL	MCL	W	NL		N	MFL	MCL	W	NL
OHB-12SE	12315	12246	12631	12494	13129	77	160	159	164	162	171
OHB-15SE	15028	14943	15413	15246	16021	98	154	153	158	156	164
OHB-18SE	19189	19081	19681	19467	20457	111	173	172	178	176	185
OHB-24SE	24662	24524	25295	25020	26293	148	167	166	171	169	178
OHB-30SE	29860	29692	30626	30293	31834	187	160	159	164	162	171
OHB-36SE	36452	36247	37387	36981	-	215	169	168	174	172	-
OHB-48SE	48178	47907	49414	48876	-	290	166	165	170	169	-
OHB-60SE	59720	59385	61252	60586	-	373	160	159	164	162	-

Ambient Ratings

Lumen Package	Standard	(HA) High Ambient	EM
OHB-12SE	55°C	-	45°C
OHB-15SE	45°C	55°C	45°C
OHB-18SE	45°C	55°C	45°C
OHB-24SE	55°C	-	45°C
OHB-30SE	45°C	50°C	45°C
OHB-36SE	45°C	55°C	45°C
OHB-48SE	55°C	-	45°C
OHB-60SE	50°C	-	45°C

Energy Data

Input Watts:
12SE (12,000 lumens)=77W
15SE (15,000 lumens)=98W
18SE (18,000 lumens)=111W
24SE (24,000 lumens)=148W
30SE (30,000 lumens)=188W
36SE (36,000 lumens)=215W
48SE (48,000 lumens)=290W
60SE (60,000 lumens)=373W

Shipping Data

Catalog No.	Wt.
OHB-12SE	10 lbs.
OHB-15SE	13 lbs.
OHB-18SE	13 lbs.
OHB-24SE	13 lbs.
OHB-30SE	16 lbs.
OHB-36SE	20 lbs.
OHB-48SE	20 lbs.
OHB-60SE	20 lbs.

Modular Power Supply Option

Modular Power Supply option is available for use with all F-Bay products. The modular power supply allows external fixture access for safe and easy servicing. There is no need to remove lamps or reflectors to disconnect fixture power with Modular Power Supply. Access to the individual fixture's power supply allows servicing without turning off all the fixtures, disrupting occupants. F-Bay Modular Power Supply is a time saver in installation – **simply plug & power.**



1. Modular Power Supply Receptacle supplied mounted into fixture Access Plate.
2. Modular Power Cord & Plugs in 120, 277, 347, & 480V configurations for easy plug & power into existing supply.

No internal fixture access required for installation or disconnecting power.

Lumen Maintenance

Ambient Temperature	TM-21 Lumen Maintenance (60,000 hours)	Theoretical L70 (Hours)
25°C	> 84%	> 117,000

Code Compliance

- UL/cUL Certified for Make/Break under load (UL2549)
- Meets NEC requirements for ballast disconnect (NEC 410.73G)
- Receptacle complete with insulating/dust cap

Control Systems

- WaveLinx
- DLVP
- LumaWatt Pro
- iLumin Plus
- VividTune



Connected Systems
[CLICK HERE](#)

We make connections work

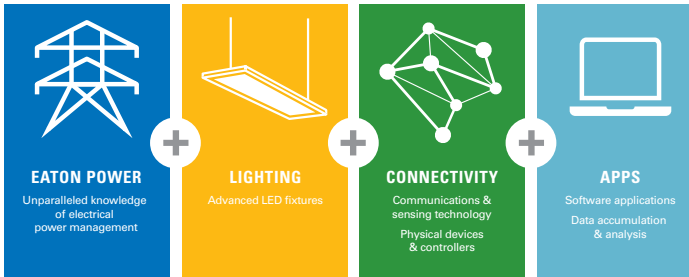

Systems comparison chart

Eaton provides many lighting system solutions designed to satisfy code requirements and meet the unique needs of any project.

	Distributed Low-Voltage Power System	WaveLinx	LumaWatt Pro
Space type	Interior	Interior/Outdoor	Any
Stand-alone or Network	Stand-alone	Both	Network
Need-based feature progression			
Basic compliance only	●	●	●
Occupancy sensing	●	●	●
Daylight harvesting	●	●	●
Zone control	●	●	●
Scheduling	●	●	●
0-10V dimming	●	●	●
Individual fixture control	●	●	●
Retrofit+Building Integration	●	●	●
Total wireless connectivity		●	●
A/V integration		●	●
BMS integration		●	●
UI options (touchscreen, apps, etc.)		●	●
Enterprise level building integration		●	●
Facility management & tools		●	●
Floor plan & reporting tools			●
Value-added services			●
Asset tracking			●
API integration		●	●
Analytics/higher problem solving			●

Dimensional and Mounting Details

OHB-12SE, 15SE

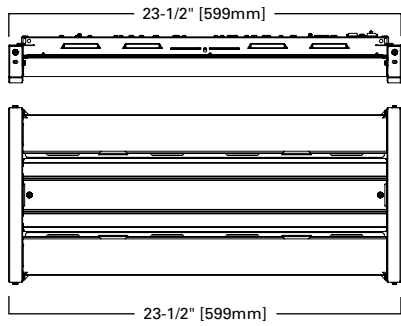
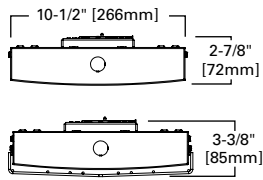

OHB-18SE, 24SE, 30SE

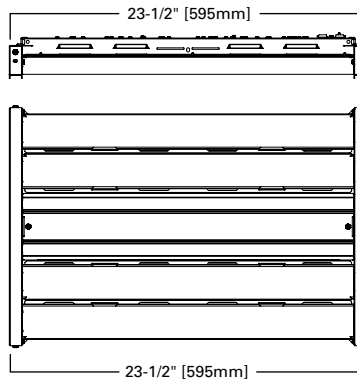
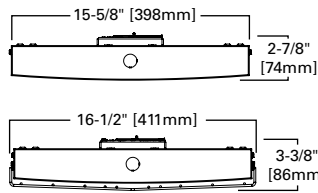

OHB-36SE, 48SE, 60SE

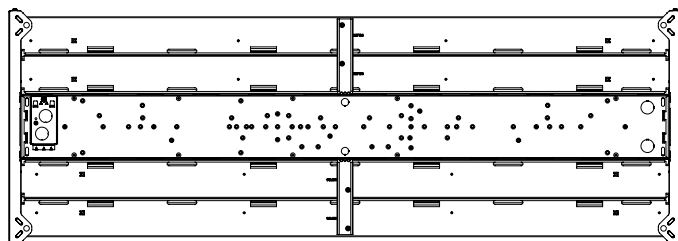
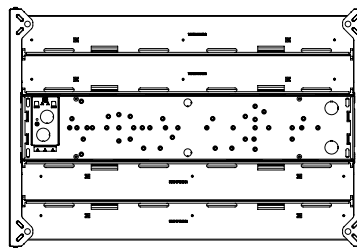
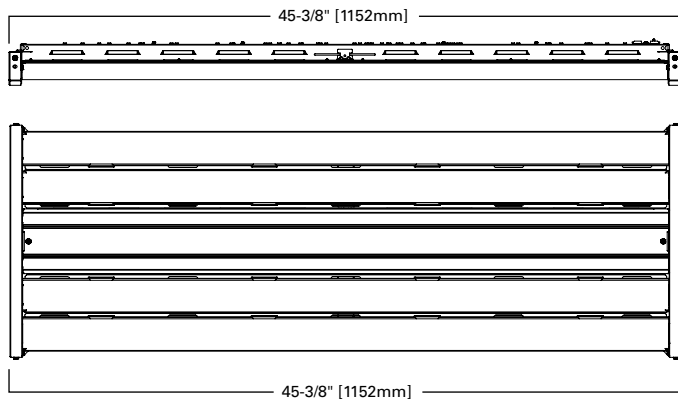
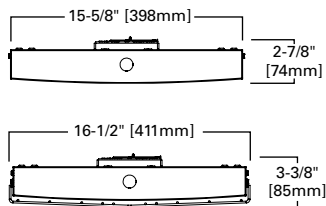

DESCRIPTION

MWS, Modular Wiring Systems, provides low cost installation of branch circuit wiring for lighting and power. Using modular components that plug together, MWS can be installed in a fraction of the time of hardwiring. Plus, MWS offers the advantage of relocating fixtures and outlets in future renovations.

The MWS Drop SO Cords (DS) are used to feed Industrial LED, HID and fluorescent lighting fixtures from a Circuit T (CT) that provides circuit selection.

Fixtures wired with MWS Drop SO Cords can be unplugged under load and relocated without interrupting power to fixtures downstream.

Catalog #		Type
Project		
Comments		Date
Prepared by		

DESIGN FEATURES

- UL Listed under Standard 183 for make or break under load.
- Meets requirements of Article 604 of the National Electrical Code.
- Galvanized steel exterior with integral keying for voltage and amperage.
- 16AWG SO cord rated at 13 amps.
- Pre-stripped leads for easy termination at fixture.
- Valox 365 constructed contact housings are approved for environmental air plenums.
- Unique double-blade contact ensures proper mating of electrical components to prevent pushback or pullout.
- Rated for single fixture feeds only.



DS

DROP SO CORD

Modular Wiring System

DIMENSIONAL DATA

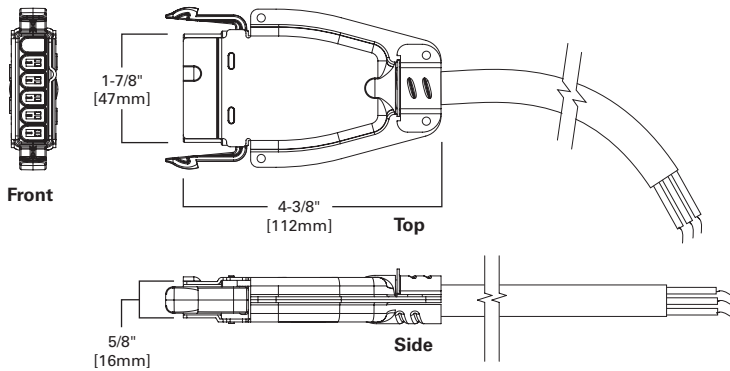

MWS AUTOCAD DRAFTING

MWS offers AutoCAD drafting to layout MWS, providing the contractor with additional benefits.

MWS design layout time is reduced.

Bills of material are computer-generated guaranteeing accuracy.

MWS drawing symbols and details standardized.

Layouts are available on CD or e-mail.

To utilize this service and for additional information, contact the MWS Sales Department (888) 487-4887.

All electrical boxes, conduit, connections and switches by others.

Install dust covers on unused open ends.

Scale is exaggerated on fixtures and MWS system applications.

SYSTEM VIEW (not to scale)

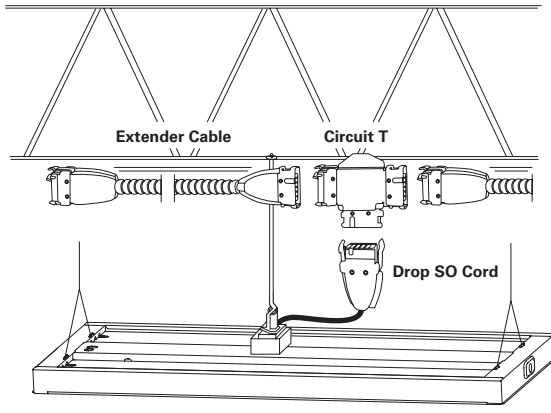
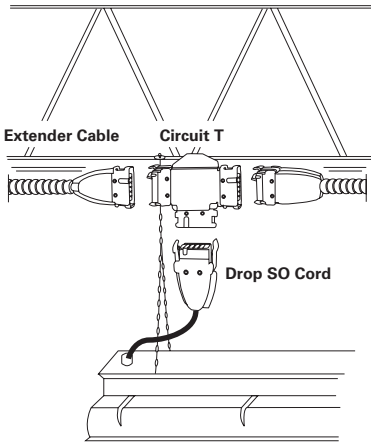

Drop SO Cord (DS)

Feeds power to fixture without interrupting circuit. Provided with 16 gauge SO Cord. For use with LED, HID and industrial fluorescents.

Typical MWS Wiring System Application shown utilizing **Drop SO Cord (DS)**.

Consult MWS Installation, Application and Specification Manual for additional comprehensive system information.

ORDERING INFORMATION

SAMPLE NUMBER: 27DS16/2G03

27	DS	16/4G	06
----	----	-------	----

Voltage 12=120V 20=208V 24=240V 27=277V 34=347V 48=480V	Component DS=Drop SO Cord	Conductors and Size 16/2G=2 Conductor and Ground 16/4G=4 Conductor and Ground	Cable Length (Feet) 03=3' 06=6' 11=11' 15=15' 21=21'	Options 2N=2 Neutral ⁽¹⁾
---	--	---	---	---

NOTES: ⁽¹⁾ 16/4G only.
Specifications & dimensions subject to change without notice. Consult your Cooper Lighting Representative for availability and ordering information.

SHIPPING DATA

Cord Length	Unit Wt.	Standard Qty./Carton
3'	1.1 lbs.	N/A
6'	1.7 lbs.	N/A
11'	3.5 lbs.	N/A
15'	4.5 lbs.	N/A
21'	6.3 lbs.	N/A