

## DESCRIPTION

The SLES Series is a strip family that incorporates premium performance and construction durability. Designed with our easy-to-use Flip-Up socket design, the SLES significantly reduces installation time. The SLES Series can be installed using various mounting methods and numerous options and accessories are available. In addition to these contractor friendly features, this series is optimized for use with LED based lamps, which are included with each shipment.

<b>Catalog #</b>		<b>Type</b>
<b>Project</b>		
<b>Comments</b>		<b>Date</b>
<b>Prepared by</b>		

## SPECIFICATION FEATURES

### Construction

Channel die formed cold rolled steel with numerous KOs for ease of installation. Groove for Tong Hanger. End plate quickly converts to snap-in channel connector for continuous row alignment. Lamp holder bracket flips in place. Channel/wireway cover secured with quarter-turn fasteners.

### Channel/Wireway Cover

Die formed heavy gauge steel. Tight fit for ease of maintenance. Easily removed without use of tools.

### Electrical

LED sources are available in "Type B" which are energized using direct wire to each lamp through specialized sockets or "Type C" through an LED driver matched with UL approved LED lamps. Our electrical systems have been tested and include protection inherent in the drivers for type C and stand alone protection for type B. These systems are cULus listed for damp locations and are rated for 120 - 277V applications.

### Finish

Multistage iron phosphate pretreatment ensures maximum bonding and rust inhibitor. Lighting upgrade, baked white enamel finish. Prepainted material is standard, PAF optional.

### Performance

Through testing and component optimization, the SLES strip line has been optimized to deliver the benefits of LED along with the maintenance benefits traditional fluorescent lamps. These fixtures utilize specialized sockets and electrical protection circuits to ensure safety, durability and electrical code compliance. Performance varies based on lamp selection and type.

### Certifications

cULus 1598 listed for damp locations. Meets FCC part 15 class A requirements. Light Engine performance complies with IESNA LM-79 and LM-80 standards. RoHS compliant. Suitable for use in clothes closets when installed in accordance with the NEC 410.16 spacing requirements. Can be used for State of California Title 24 high efficacy luminaire.



## SLES

(Socket-Fit Light Engine) Striplight

### Non-Dimming:

- SB - Single Ended Type B - with internal protection
- DB - Dual Ended Type B
- DC - Type C - Driver based

### Dimming:

- SBDIM - Type B with 0-10V dimming
- DCDIM - Type C with 0-10V dimming

**2', 4' OR 8' STRIP**  
**1 OR 2 LAMPS**  
**T8 LAMP SHAPE/LENGTH**

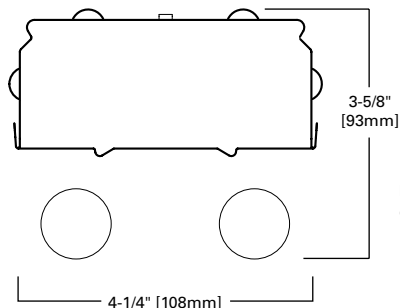

Note: Shape of lamp may not be exactly as depicted in line art.

## MOUNTING DATA

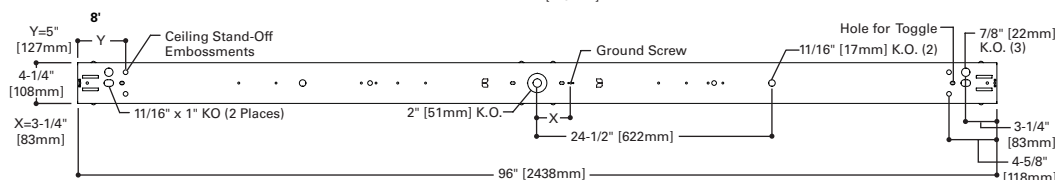
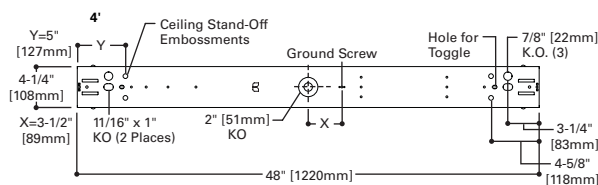
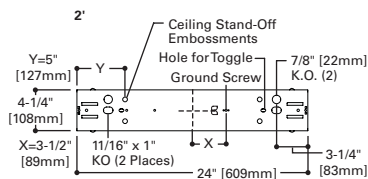

## LAMP CONFIGURATIONS

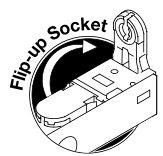
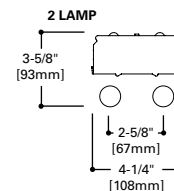
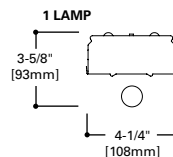

## LOAD DATA

	2'	4'	8'
PF	> .9		
THD%	< 20%		
Low Temp Start	-20° C		
Max Ambient Temp	45° C		
Weight lbs. (based on 2 rows lamps)	4.8	6.6	14.6

## LINEAR DISCONNECT

Safe and convenient means of disconnecting power



PHOTOMETRICS

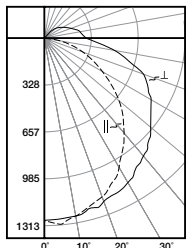

**SLES-2SB18-L835-UNV**

Electronic Driver  
 Linear LED 3500K  
 Spacing criterion:  
 (II) 1.21 x mounting  
 height, (L) 1.35 x  
 mounting height  
 Lumens: 4899  
 Input Watts: 36.7W  
 Efficacy: 133.5 lm/W  
 Test Report:  
 SLES-2SB18-L835-  
 UNV.IES

**Candlepower**

Angle	Along II	45°	Across L
0	1283	1283	1283
5	1313	1272	1277
10	1270	1263	1271
15	1222	1236	1237
20	1187	1208	1220
25	1122	1144	1203
30	1050	1106	1165
35	956	1042	1110
40	866	991	1078
45	780	914	1027
50	678	840	971
55	582	773	910
60	481	699	866
65	382	629	796
70	291	566	742
75	192	500	597
80	106	390	479
85	35	274	371
90	1	195	294

**Coefficients of Utilization**

rc rw RCR	Effective floor cavity reflectance																									
	80%				70%				50%				30%				10%				0%					
	70	50	30	10	70	50	30	10	50	30	10	50	30	10	50	30	10	50	30	10	50	30	10	50	30	10
0	117	117	117	117	113	113	113	113	105	105	105	99	99	99	93	93	93	90								
1	104	98	93	89	100	95	91	86	89	85	82	83	80	77	78	76	73	70								
2	94	84	77	70	90	82	75	69	76	71	66	71	67	62	67	63	60	57								
3	85	73	64	57	81	71	63	56	66	60	54	62	57	52	58	54	49	47								
4	77	65	55	48	74	62	54	47	59	51	45	55	49	44	52	46	42	39								
5	71	57	48	41	68	56	47	40	52	45	39	49	43	37	46	41	36	34								
6	65	51	42	35	63	50	41	35	47	39	34	44	38	33	42	36	31	29								
7	60	46	37	31	58	45	37	31	43	35	30	40	34	29	38	32	28	26								
8	56	42	34	27	54	41	33	27	39	32	26	37	30	26	35	29	25	23								
9	52	39	30	25	50	38	30	24	36	29	24	34	28	23	32	27	22	20								
10	49	36	28	22	47	35	27	22	33	26	21	31	25	21	30	24	20	18								

**Zonal Lumen Summary**

Zone	Lumens	% Fixture
0-30	1003	20.5
0-40	1655	33.8
0-60	3038	62.0
0-90	4403	89.9
0-180	4899	100.0

**Luminance Data**

Angle in Deg	Average 0-Deg cd/sm	Average 45-Deg cd/sm	Average 90-Deg cd/sm
45	7676	7374	7817
55	6970	7068	7713
65	6079	6878	7882
75	4767	7065	7376
85		2123	5716
			6351

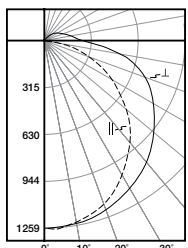

**SLES-2DC18-L835-UNV**

Electronic Driver  
 Linear LED 3500K  
 Spacing criterion:  
 (II) 1.22 x mounting  
 height, (L) 1.36 x  
 mounting height  
 Lumens: 4730  
 Input Watts: 34.8W  
 Efficacy: 135.9 lm/W  
 Test Report:  
 SLES-2DC18-L835-  
 UNV.IES

**Candlepower**

Angle	Along II	45°	Across L
0	1254	1254	1254
5	1254	1246	1250
10	1234	1232	1241
15	1201	1208	1225
20	1155	1176	1205
25	1097	1136	1177
30	1032	1088	1142
35	958	1035	1102
40	877	975	1057
45	791	912	1008
50	699	845	953
55	605	776	895
60	507	702	837
65	406	631	780
70	303	568	711
75	203	500	635
80	108	418	504
85	32	282	358
90	1	157	233

**Coefficients of Utilization**

rc rw RCR	Effective floor cavity reflectance																									
	80%				70%				50%				30%				10%				0%					
	70	50	30	10	70	50	30	10	50	30	10	50	30	10	50	30	10	50	30	10	50	30	10	50	30	10
0	117	117	117	117	114	114	114	114	107	107	107	101	101	101	95	95	95	93								
1	105	99	94	89	101	96	91	87	90	86	83	85	82	79	80	78	75	73								
2	94	85	77	70	91	82	75	69	77	71	66	73	68	64	69	65	61	58								
3	85	74	65	57	82	71	63	56	67	60	54	63	58	53	60	55	51	48								
4	78	65	55	48	75	63	54	47	59	52	46	56	50	44	53	47	43	40								
5	71	57	48	41	68	56	47	40	53	45	39	50	43	38	47	42	37	34								
6	66	51	42	35	63	50	41	35	48	40	34	45	38	33	43	37	32	30								
7	61	47	37	31	58	45	37	31	43	35	30	41	34	29	39	33	28	26								
8	56	42	33	27	54	41	33	27	39	32	26	38	31	26	36	30	25	23								
9	52	39	30	25	51	38	30	24	36	29	24	35	28	23	33	27	23	21								
10	49	36	28	22	48	35	27	22	33	26	21	32	26	21	31	25	21	19								

**Zonal Lumen Summary**

Zone	Lumens	% Fixture
0-30	986	20.8
0-40	1633	34.5
0-60	3017	63.8
0-90	4387	92.7
0-180	4730	100.0

**Luminance Data**

Angle in Deg	Average 0-Deg cd/sm	Average 45-Deg cd/sm	Average 90-Deg cd/sm
45	7784	7358	7672
55	7246	7096	7586
65	6461	6900	7723
75	5040	7065	7846
85		1941	5883
			6128

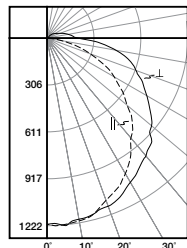

**SLES-2SB DIM18-L835-UNV**

Electronic Driver  
 Linear LED 3500K  
 Spacing criterion:  
 (II) 1.25 x mounting  
 height, (L) 1.33 x  
 mounting height  
 Lumens: 4251  
 Input Watts: 34.1W  
 Efficacy: 124.7 lm/W  
 Test Report:  
 SSF-SLES-2SB-  
 DIM18-L835-UNV.  
 IES

**Candlepower**

Angle	Along II	45°	Across L
0	1207	1207	1207
5	1212	1186	1222
10	1204	1185	1194
15	1178	1159	1182
20	1119	1128	1160
25	1078	1083	1127
30	1012	1036	1071
35	934	967	1029
40	844	911	995
45	774	845	954
50	678	777	879
55	591	702	806
60	496	612	742
65	401	552	680
70	298	483	612
75	201	419	541
80	104	338	450
85	30	237	318
90	1	127	198

**Coefficients of Utilization**

rc rw RCR	Effective floor cavity reflectance																									
	80%				70%				50%				30%				10%				0%					
	70	50	30	10	70	50	30	10	50	30	10	50	30	10	50	30	10	50	30	10	50	30	10	50	30	10
0	118	118	118	118	114	114	114	114	108	108	108	102	102	102	97	97	97	95								
1	105	100	95	90	102	97	92	88	92	88	84	87	84	81	82	80	77	75								
2	95	86	78	72	92	83	76	70	79	73	68	75	70	65	71	67	63	61								
3	86	75	66	59	83	73	64	58	69	62	56	65	59	54	62	57	53	50								
4	79	66	56	49	76	64	55	48	61	53	47	58	51	46	55	49	45	42								
5	72	58	49	42	69	57	48	41	54	46	40	52	45	39	49	43	39	36								
6	66	52	43	36	64	51	42	36	49	41	35	47	40	34	44	38	34	31								
7	61	47	38	32	59	46	38	32	44	37	31	42	35	30	41	34	30	28								
8	57	43	34	28	55	42	34	28	40	33	28	39	32	27	37	31	27	25								
9	53	40	31	25	52	39	31	25	37	30	25	36	29	24	34	28	24	22								
10	50	36	28	23	48	36	28	23	34	27	22	33	27	22	32	26	22	20								

**Zonal Lumen Summary**

Zone	Lumens	% Fixture
0-30	946	22.2
0-40	1556	36.6
0-60	2836	66.7
0-90	4021	94.6
0-180	4251	100.0

**Luminance Data**

Angle in Deg	Average 0-Deg cd/sm	Average 45-Deg cd/sm	Average 90-Deg cd/sm
45	7617	6818	7261
55	7078	6419	6832
65	6381	6036	6733
75	4991	5921	6684
85		1820	4944
			5443

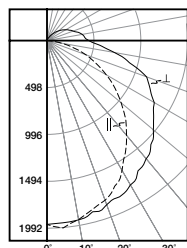

## PERFORMANCE IN FIXTURE - TYPE B

Lamp Rows	Strip Catalog Prefix	Strip Length	Lamp Designations: Type, Watts, CRI, CCT <sup>1</sup>	Nominal Lumens @3500K <sup>2</sup>	Watts	Efficacy	Input Current (A) @120V
Type B Non-Dimming							
1	2SLES-1SB	2'	SB7-L8XX or DB7-L8XX	780	7	111	0.058
	SLES-1SB	4'	SB11-L8XX or DB11-L8XX	1784	11.5	155	0.096
			SB12-L8XX	1834	12.5	147	0.104
			SB15-L8XX or DB15-L8XX	1883	15	126	0.125
			SB18-L8XX	2478	18.5	134	0.154
	8TSLES-1SB	8'	SB11-L8XX or DB11-L8XX	3568	23	155	0.192
			SB12-L8XX	3667	25	147	0.208
			SB15-L8XX or DB15-L8XX	3767	30	126	0.250
			SB18-L8XX	4956	37	134	0.308
	2	2SLES-1SB	2'	SB7-L8XX or DB7-L8XX	1482	14	106
SLES-1SB		4'	SB11-L8XX or DB11-L8XX	3527	23	153	0.192
			SB12-L8XX	3625	25	145	0.208
			SB15-L8XX or DB15-L8XX	3723	30	124	0.250
			SB18-L8XX	4899	37	132	0.308
8TSLES-1SB		8'	SB11-L8XX or DB11-L8XX	7055	46	153	0.383
			SB12-L8XX	7251	50	145	0.417
			SB15-L8XX or DB15-L8XX	7446	60	124	0.500
			SB18-L8XX	9798	74	132	0.617
Type B Dimming							
1	SLES-1SB	4'	SBDIM18-8XX	2160	17.5	123	0.146
	8TSLES-1SB	8'		4320	35	123	0.292
2	SLES-2SB	4'		4251	35	121	0.292
	8TSLES-2SB	8'		8502	70	121	0.583

Notes: <sup>1</sup> Lamps available in 3000K, 3500K, 4000K, and 5000K. Designate in catalog number when ordering. <sup>2</sup> Performance data at 25°C and may change depending upon lamps used. Use IES files for confirmation prior to install.

## PERFORMANCE IN FIXTURE - TYPE C

Lamp Rows	Strip Catalog Prefix	Strip Length	Lamp Designations: Type, Watts, CRI, CCT <sup>1</sup>	Nominal Lumens @3500K <sup>2</sup>	Watts	Efficacy	Input Current (A) @120V
Type C Non-Dimming							
1	2SLES-1DC	2'	DC7-L8XX	845	7	121	0.058
	SLES-1DC	4'	DC13-L8XX	1478	12	123	0.100
			DC16-L8XX	1971	15	131	0.125
	8TSLES-1DC	8'	DC13-L8XX	2956	24	123	0.200
DC16-L8XX			3942	30	131	0.250	
2	2SLES-1DC	2'	DC7-L8XX	1665	14	119	0.117
	SLES-1DC	4'	DC13-L8XX	2956	24	123	0.200
			DC16-L8XX	3942	30	131	0.250
	8TSLES-1DC	8'	DC13-L8XX	5913	48	123	0.400
			DC16-L8XX	7883	60	131	0.500
Type C Dimming							
1	SLES-1DC	4'	DCDIM13-L8XX	1971	14	141	0.117
			DCDIM16-L8XX	2266	16.5	137	0.138
	8TSLES-1DC	8'	DCDIM13-L8XX	3942	28	141	0.233
			DCDIM16-L8XX	4533	33	137	0.275
2	SLES-2DC	4'	DCDIM13-L8XX	3942	28	141	0.233
			DCDIM16-L8XX	4533	33	137	0.275
	8TSLES-2DC	8'	DCDIM13-L8XX	7883	56	141	0.467
			DCDIM16-L8XX	9066	66	137	0.550

Notes: <sup>1</sup> Lamps available in 3000K, 3500K, 4000K, and 5000K. Designate in catalog number when ordering. <sup>2</sup> Performance data at 25°C and may change depending upon lamps used. Use IES files for confirmation prior to install.

**ORDERING INFORMATION TYPE B LAMPS**

TYPE B SAMPLE STRIP NUMBER: 8TSLES-2DC-PI2BLK-WG-6PP-IEM1-U

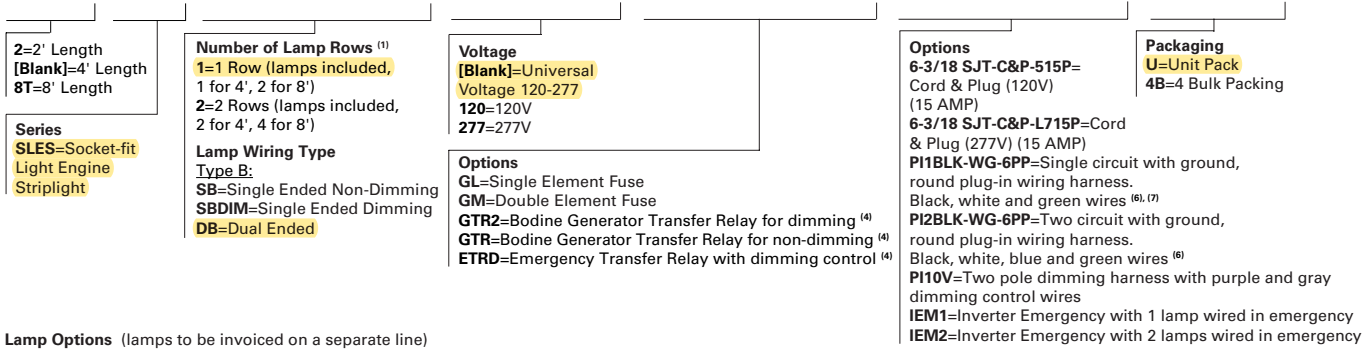

**Lamp Options** (lamps to be invoiced on a separate line)  
TYPE B SAMPLE LAMP OPTIONS NUMBER: SBDIM18-L840 (Dimming Type B, 18 Watts, 80 CRI, 4000K)

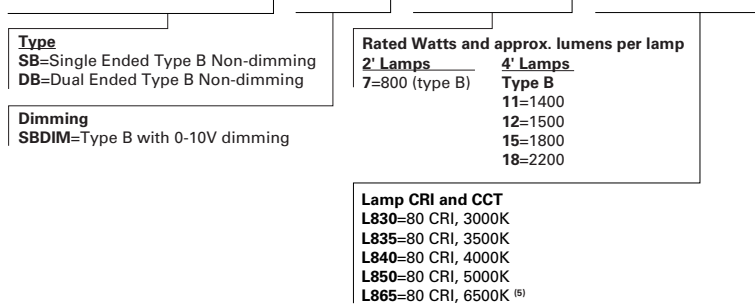

**NOTES:** <sup>(2)</sup> Lamps are supplied by Eaton and must be shipped according to Eaton standards and test requirements. Lamps will be bulk packed based on order requirements and may have minimum order quantities. <sup>(4)</sup> Used to bypass local control during outage. Must be used in conjunction with UL 1008 device (provided by others). GTR requires 2 relays on fixtures with dimming. ETRD option only requires one relay when used on a dimming fixture. Must specify voltage as 120V or 277V when ordering these devices. <sup>(5)</sup> Available in SB15 only. <sup>(6)</sup> Must use 2 wire harness when used with emergency options. <sup>(7)</sup> Only use for non-EM installations.

Specifications & dimensions subject to change without notice. Consult your Eaton Representative for availability and ordering information.

**ORDERING INFORMATION TYPE C LAMPS**

TYPE C SAMPLE STRIP NUMBER: 8TSLES-2DC-PI2BLK-WG-6PP-IEM1-U

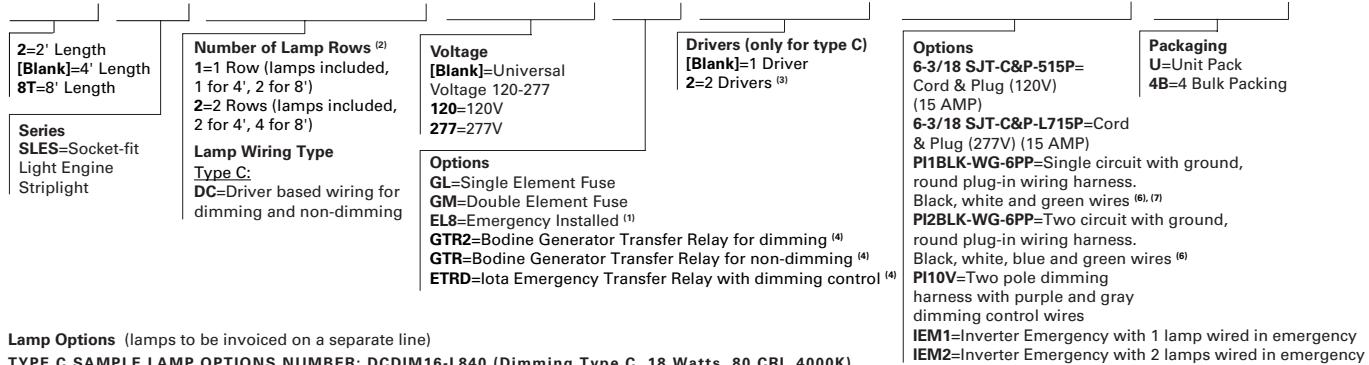

**Lamp Options** (lamps to be invoiced on a separate line)  
TYPE C SAMPLE LAMP OPTIONS NUMBER: DCDIM16-L840 (Dimming Type C, 18 Watts, 80 CRI, 4000K)

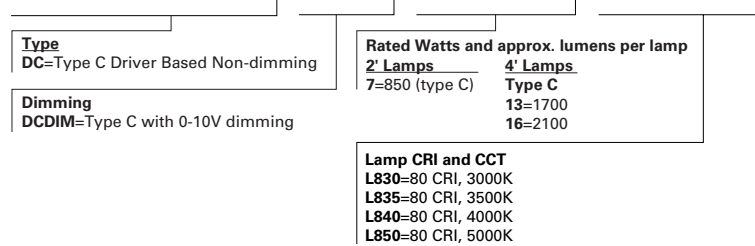

**NOTES:** <sup>(1)</sup> Emergency options converter based with type C systems using internally installed battery LED driver and matched LED lamps. <sup>(2)</sup> Lamps are supplied by Eaton and must be shipped according to Eaton standards and test requirements. Lamps will be bulk packed based on order requirements and may have minimum order quantities. <sup>(3)</sup> 2 drivers is only available with 2 row options or 8' single row options. Ex. 2 drivers for 8TSLES will be wired to control each row. <sup>(4)</sup> Used to bypass local control during outage. Must be used in conjunction with UL 1008 device (provided by others). GTR requires 2 relays on fixtures with dimming. ETRD option only requires one relay when used on a dimming fixture. Must specify voltage as 120V or 277V when ordering these devices.

Specifications & dimensions subject to change without notice. Consult your Eaton Representative for availability and ordering information.

**SHIPPING DATA**

Catalog No.	Wt.
2SLES	4.0 lbs.
SLES	5.1 lbs.
8TSLES	10.2 lbs.



Eaton  
1121 Highway 74 South  
Peachtree City, GA 30269  
P: 770-486-4800  
www.eaton.com/lighting

Specifications and dimensions subject to change without notice.