

High Pressure Sodium Core & Coil Ballast Kit 47316 LU100/MULTI-KIT

FOR ONE 100 WATT, S54 HPS

Line Voltage	120/208/240/277V
Regulation	
Line Volts	+/-5%
Line Watts	WITHIN TRAPEZOID
Frequency	60 Hz
Circuit Type	HX-HPF
Power Factor (min)	90%
Insulation Class	H(180°)
Min. Ambient Starting Temp.	-40° F or -40° C

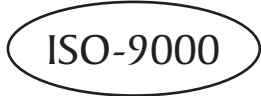

Line Voltage (Volts)	120	208	240	277
Line Current (Amps)				
Operating	1.14	0.66	0.57	0.49
Open Circuit	2.0	1.16	1.0	0.87
Starting	1.09	0.62	0.55	0.46
Input Watts (W)	128	128	128	128
Open Circuit Voltage (V)	120	120	120	120
Drop Out Voltage (V)	96	166	192	222
UL(1029) Bench Top Rise	A	A	A	A
Recommended Fuse (Amps)	7	5	3	3

HIGH POTENTIAL TEST (VOLTS)	
1 Minute	2000
2 Seconds	2500
Open Circuit Voltage Test (volts)	110 - 135
Short-Circuit Current Test (Amps)	
Secondary Current	2.4 - 3.0
Input Current (Amps)	0.72-1.2 0.40-0.70 0.35-0.60 0.30-0.52

3" x 4" CORE

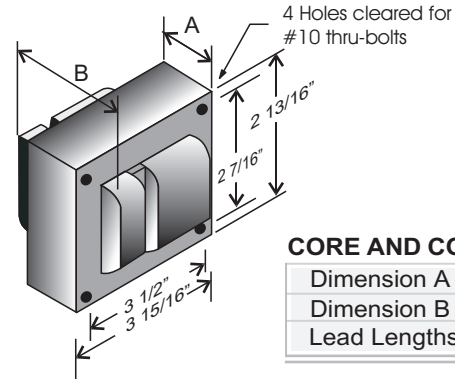

CORE AND COIL

Dimension A (inches)	2.00
Dimension B (inches)	3.40
Lead Lengths (inches)	12

IGNITOR 37-63-AS-9.1-N7

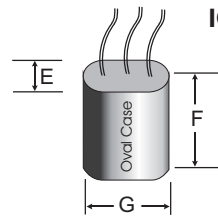

(THERMAL PLASTIC CASE)
Max. case temp
110° C

NAED: XXXXX

Dimension E (inches)	1.17
Dimension F (inches)	2.5
Dimension G (inches)	1.9

Maximum Distance To Lamp: 2 feet

CAPACITOR

Thermal Plastic Case
Max. Case Temp. 100° C

NAED: XXXXX

RATING: 10 µF ± 3%, 280 VAC MIN.
Dry Film Capacitor. NO PCB'S

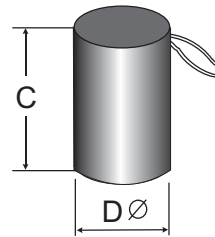

Dimension C (inches)	2.90
Dimension D (inches)	1.50

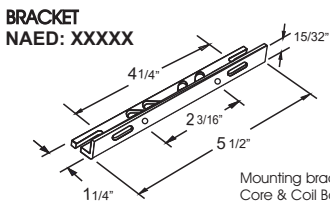

BRACKET
NAED: XXXXX

Mounting bracket for
Core & Coil Ballasts
(1 bracket with thru bolts)

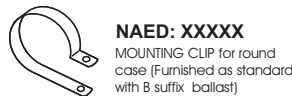

NAED: XXXXX
MOUNTING CLIP for round case (Furnished as standard with B suffix ballast)

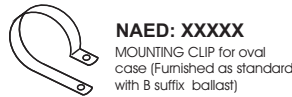

NAED: XXXXX
MOUNTING CLIP for oval case (Furnished as standard with B suffix ballast)

PRODUCT LABEL

SYLVANIA **Lamp Type** S54 100W HPS

LU100/MULTI-KIT

120/208/240/277V
1.14/0.66/0.57/0.49 A
120Voc.60Hz.HX-HPF
Max. Input Current without lamp: 2.0 A

47316-4

1029A Class H
Ground Ballast Core
86-180-4
Made in Mexico

Caution: High Voltage Pulse Present on Open Circuit

10 µF-280VAC-MIN

CARTON LABEL

SYLVANIA 1 Ballast Kit 1 SKU's

LU100/MULTI-KIT S54

LUMALUX® 120/208/240/277V

Magnetic Ballast / Ballast magnétique Mexico

47316-4

1 00 46135 47316 3

WIRING DIAGRAM H

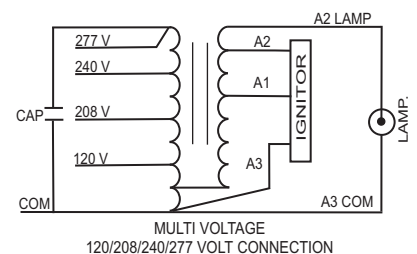

CARTON CHARACTERISTICS

UNITS CARTON	CARTON/LAYER	# OF LAYERS	UNITS PALLET	PIECE WEIGHT	CARTON WEIGHT	PALLET WEIGHT
1	42	8	336	6.15 Lbs	6.50 Lbs	2219 Lbs
CARTON PALLET	CARTON DIMENSIONS	PALLET DIMENSIONS	PALLET DIMENSIONS LOADED, INCLUDING WOOD PALLET			
336	6 3/4" x 6 3/8" x 3 3/4"	40" x 48" x 7"	40" x 48" x 37"			

MISC.

Item Number **47316 LU100/MULTI-KIT**

HIGH PRESSURE SODIUM **Line Voltage**

Primary Lamp Wattage