

Metal Halide Pulse Start Core & Coil Ballast Kit 47400 M400/SUPER5-PS-KIT

FOR ONE 400 WATT, M135 MH PS
OR 400 WATT M155 MH PS

Line Voltage	120/208/240/277/480 V
Regulation	
Line Volts	+/-10%
Line Watts	+/-10%
Frequency	60 Hz
Circuit Type	SUPER-CWA
Power Factor (min)	90%
Insulation Class	H(180°)
Min. Ambient Starting Temp.	-20° F or -30° C

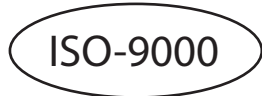

Line Voltage (Volts)	120	208	240	277	480
Line Current (Amps)					
Operating	3.80	2.30	1.90	1.65	0.95
Open Circuit	2.70	1.60	1.30	0.80	0.65
Starting	3.00	1.70	1.50	1.20	0.75
Input Watts (W)	454	454	454	454	454
Open Circuit Voltage (V)	275	275	275	275	275
Drop Out Voltage (V)	60	104	120	138	240
UL(1029) Bench Top Rise	B	D	D	B	D
Recommended Fuse (Amps)	10	7	5	5	3

HIGH POTENTIAL TEST (VOLTS)	
1 Minute	2000
2 Seconds	2500
Open Circuit Voltage Test (volts)	250 - 305
Short-Circuit Current Test (Amps)	
Secondary Current	3.60 - 4.40
Input Current (Amps)	2.20 - 3.40, 1.35 - 2.10, 1.10 - 1.70, 0.75 - 1.30, 0.55 - 0.85

4 1/4" x 4 3/4" CORE

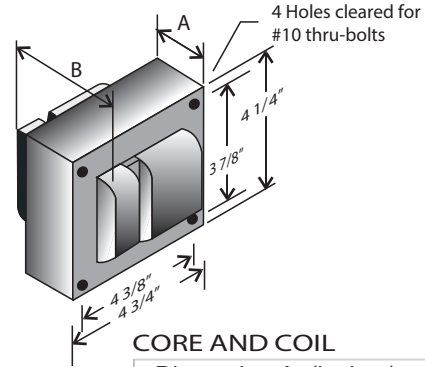

CORE AND COIL

Dimension A (inches)	2.20
Dimension B (inches)	4.30
Lead Lengths (inches)	12

IGNITOR
(THERMAL PLASTIC CASE)
Max. case temp
105° C

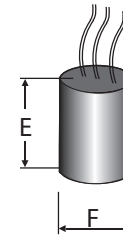

Dimension E (inches)	2.5
Dimension F (inches)	1.25

Maximum Distance to Ballast: 2 feet

BRACKET
CORE & COIL
MOUNTING BRACKET

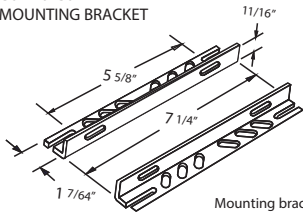

Mounting bracket for
Core & Coil Ballasts
(2 brackets with thru bolts)

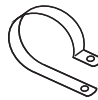

MOUNTING CLIP for round
case (Furnished as standard
with B suffix ballast)



MOUNTING CLIP for round
case (Furnished as standard
with B suffix ballast)

CAPACITOR

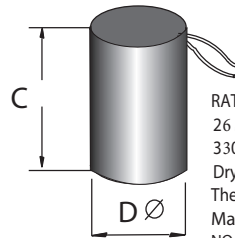

RATING
26 Mfd ± 3%
330 VAC MIN
Dry Film Capacitor
Thermal Plastic Case
Max. C case Temp 105° C
NO PCB'S

Dimension C (inches)	4.8
Dimension D (inches)	1.75

PRODUCT LABEL

OSRAM Lamp Types
M135 400W MH
M400/SUPER5-PS-KIT M155 400W MH

120/208/240/277/480V
3.80/2.30/1.90/1.65/0.95A
275 Voc, 60Hz, CWA



Class H
Ground Ballast Core
Assembled in Mexico

Caution: High Voltage Pulse Present on Open Circuit

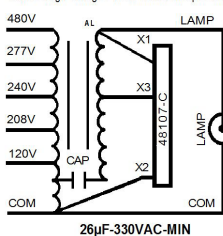

CARTON LABEL

OSRAM 1 Ballast Kit 1 SKU
M400/SUPER5-PS-KIT M135/M155
METALARC 120/208/240/277/480V
Magnetic Ballast / Ballast magnétique Assembled in Mexico



1 0 0 4 6 1 3 5 4 7 4 0 0 9

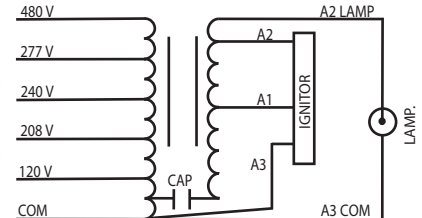

SUPER 5
120/208/240/277/480 VOLT CONNECTION

WIRING DIAGRAM F

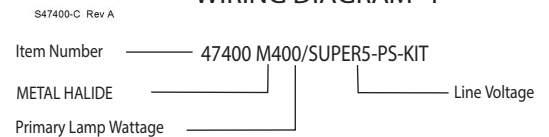

CARTON CHARACTERISTICS

UNITS CARTON	CARTON/LAYER	# OF LAYERS	UNITS PALLET	PIECE WEIGHT	CARTON WEIGHT	PALLET WEIGHT
1	30	5	150	16.00 Lbs.	16.0 Lbs.	2400 Lbs.
CARTON PALLET	CARTON DIMENSIONS	PALLET DIMENSIONS	PALLET DIMENSIONS LOADED, INCLUDING WOOD PALLET			
150	8.125" x 5.125" x 4.9375"	48" x 40" x 5"	48" x 40" x 30"			