

# QUICKTRONIC® PROStart® T5HO

347-480V High Ambient Temp. Systems  
High Efficiency Series



**Type CC**  
**Programmed Rapid Start**  
**Normal Ballast Factor HT**

**QHE T5HO  
347-480V HT**

## Lamp / Ballast Guide

**54W T5 – PENTRON® HO lamps**  
1 or 2-lamp:  
QHE2x54T5HO/347-480 PSN-HT  
4-lamp Switchable:  
QHE4x54T5HO/347-480 PSN-HT-SCL  
Also operates:  
FP54/SS, FT50DL, FT55DL, FPC55, L58T8  
1 or 2 lamps on 2L ballast  
1, 2, 3 or 4 lamps on 4L ballast

## Key System Features

- High Efficiency Systems over 90% efficient
- 90°C maximum case temp.
- 347-480V input voltage range
- 1.0 ballast factor (see table)
- QUICKSENSE® ballast technology (end-of-lamp-life sensing)
- PROStart programmed rapid start
- UL type CC rated
- -20°F (-29°C) min. starting temp.
- Operates at >42 kHz to reduce potential interference with infrared control systems
- High power factor
- Low harmonic distortion
- Lightweight
- UL, CSA, FCC
- RoHS compliant
- Lead-free solder and manufacturing process



## Application Information

QUICKTRONIC High Efficiency T5HO HT ballasts are ideally suited for:

- Industrial high-bay
- Commercial
- Retail
- Hospitality
- Institutional
- New construction
- Direct lighting
- Indirect lighting
- Surface mount
- Cove lighting

## QUICKTRONIC High Efficiency (QHE)

PROStart® T5HO 347-480V High Ambient (HT) electronic ballasts operate SYLVANIA PENTRON HO, PENTRON HO Circline, and DULUX® L T5 lamps with full lumen output and optimal system performance.

QUICKTRONIC T5HO 347-480V HT electronic ballasts allow operation in industrial applications using a 480V AC system. This eliminates the need to rewire existing 480V installations or to drop the voltage by using expensive and bulky transformers. The same product can also be used for 347V applications, allowing for a reduction in inventory model numbers.

QUICKTRONIC T5HO 347-480V HT ballasts are specifically designed for high ambient temperature applications. The ballast may be operated at case temperatures of up to 90°C, making them an ideal choice for high ambient settings such as industrial high-bay lighting.

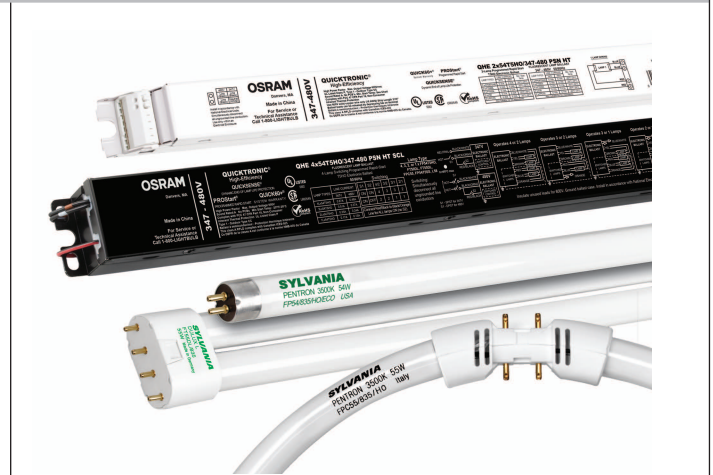

QUICKTRONIC T5HO 347-480V HT ballasts are RoHS compliant and feature lead-free solder and manufacturing process.

are covered by the QUICK 60+® warranty, the first and most comprehensive system warranty in the industry.

Setting the standard for quality, QUICKTRONIC T5HO 347-480V HT ballasts

## System Information

QUICKTRONIC High Efficiency PROStart T5HO 347-480V High Ambient System:

- Voltage errors
  - Reduces inventory by 50%
- Utilizes Programmed Rapid Start operation for:
  - Highest System Efficacy
  - Longer Life
  - Over 100,000 switching cycles for occupancy sensor and building control systems applications

QUICKSENSE ballast technology helps to protect against overheated bases and sockets, as well as cracking of the glass wall, and uses dynamic end-of-lamp-life sensing to avoid false shutdowns caused by some static sensing methods. QUICKSENSE ballast technology will auto reset when the end-of-life lamps are replaced with new ones.

The two lamp unit can be wired for two or one lamp operation. The four lamp “switching” ballast is designed to switch from 4 to 2-lamps, 3 to 2-lamps, 3 to 1-lamp or 2 to 1-lamp. The switching feature can be used with control interfaces, including occupancy sensors.

System Type	Input System Power (W)	Initial Fixture* LPW	Mean Fixture* Lumens	Relative Fixture* Output	Energy Savings (%)
M400/U (1-lamp) Magnetic Ballast	452	61	17,784	Baseline	Baseline
FP54T5HO (4-lamps) QHE4x54T5HO/347-480 PSN-HT-SCL	228	79	16,740	94%	50%
FP54/50W/SS (4-lamps) QHE4x54T5HO/347-480 PSN-HT-SCL	207	89	17,075	96%	54%
FP54/47W/SS (4-lamps) QHE4x54T5HO/347-480 PSN-HT-SCL	203	83	15,625	88%	55%

\*Based on Fixture efficiency: 76% for M400 and 90% for FP54T5HO

\*480V input voltage

\*Lumen Output for T5HO @ 35°C/95°F

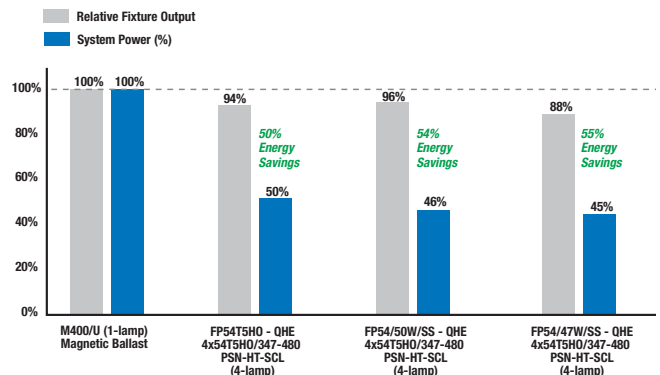

**SPECIFICATION DATA**

Catalog # \_\_\_\_\_ Date \_\_\_\_\_ Type \_\_\_\_\_

Project \_\_\_\_\_ Prepared by \_\_\_\_\_

Comments \_\_\_\_\_

**2 Lamp, High Efficiency, Type CC, High Ambient (347-480V)**



**T5HO 2 Lamp 347-480V HT  
Fixed Output Ballast**

**High Efficiency**

**Lamp / Ballast Guide**

**Wiring Diagram**

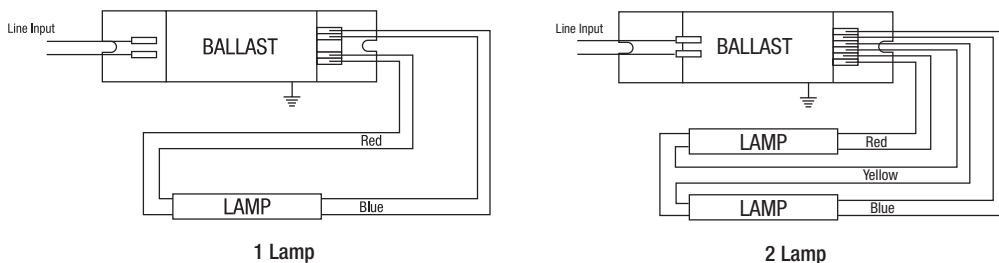

	480V	347V
Line Input	Line (Black)	Line (Black)
	Line (Black)	Neutral (White)



**Installation Notes**

- For 480V applications connect two phases (line and line) to the input.
- For 347V applications connect line and neutral to the input as shown (DO NOT CONNECT two phases of 347V to the same ballast)
- Switching: Simultaneously disconnect all ungrounded line conductors per NEC codes (i.e. switch both hot legs)
- Ground ballast case
- Insulate unused leads for 600V
- Install in accordance with the National Electrical Code

**Dimensions:**

**Model QHE2x54T5HO/347-480 PSN-HT enclosure size:**

Overall: 16.73"L x 1.18"W x 1.00"H (425mm L x 30mm W x 25.4mm H)

Mounting: 16.34" (415mm)

**Wiring:**

- 51486: Push-in connectors
- 51485: Push-in connectors with leads
- Use 18AWG solid copper wire only

**Product Weight:**

- 51486: 0.88 lb (0.40kg) each (approx.)
- 51485: 1.0 lb (0.45kg) each (approx.)

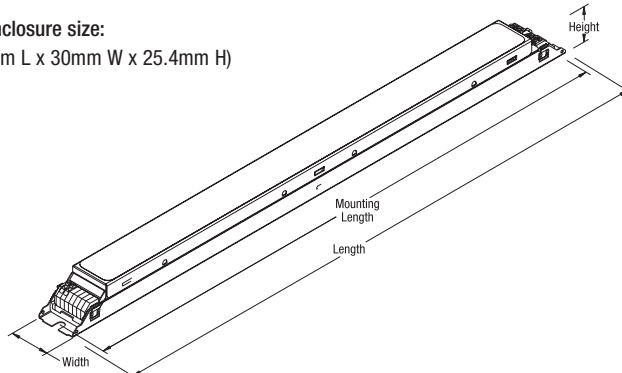

**Dimensions:**

**Model QHE4x54T5HO/347-480 PSN-HT-SCL enclosure size:**

Overall: 16.73"L x 1.68"W x 1.18"H (425mm L x 43mm W x 30mm H)

Mounting: 16.34" (415mm)

**Wiring:**

- 51481: Leads only (no connectors provided)

**Product Weight:**

- 51481: 2.4 lbs (1.08kg) each (approx.)

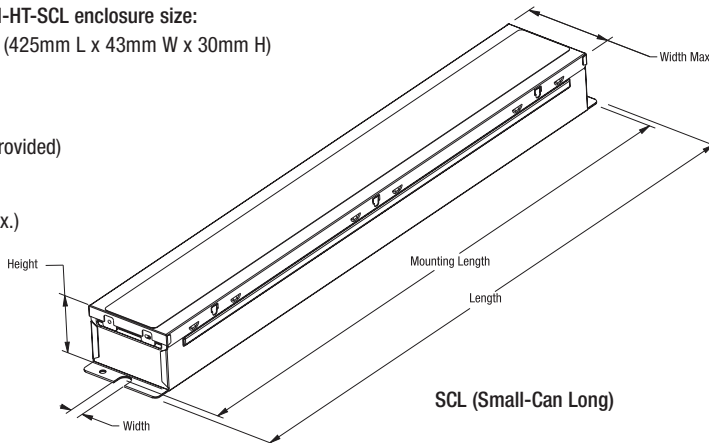

Products distributed by  
LEDVANCE LLC

For Customer Service contact  
1-800 LIGHTBULB

Specifications subject to change without notice.



**QHE T5HO  
347-480V HT**

**SPECIFICATION DATA**

Catalog # \_\_\_\_\_ Date \_\_\_\_\_ Type \_\_\_\_\_

Project \_\_\_\_\_ Prepared by \_\_\_\_\_

Comments \_\_\_\_\_

**4 Lamp, High Efficiency, Type CC, High Ambient (347-480V)**



**T5HO 4 Lamp 347-480V HT Switchable Ballast**

**High Efficiency**

**Lamp / Ballast Guide**



**OHE T5HO  
347-480VHT**

**Wiring Diagrams**

**High Ambient Switchable Model (90°C case temp.)**

51481 QHE4x54T5HO/347-480 PSN-HT-SCL

**4-Lamp Switching Wiring Diagram (4L to 2L)**

S1	S2	4/2
ON	ON	4
ON	OFF	2

For fixed output, S2 not used.  
Connect red/black lead to black/orange lead.

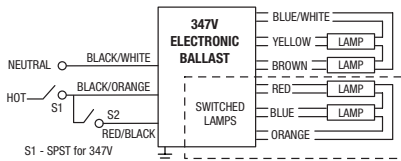

Operates 4 or 2 Lamps

Switching: Simultaneously disconnect all ungrounded line conductors

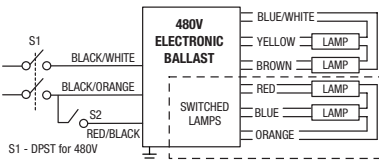

**3-Lamp Switching Wiring Diagram (3L to 2L, 3L to 1L)**

S1	S2	3/2	3/1
ON	ON	3	3
ON	OFF	2	1

Operates 3 or 2 Lamps

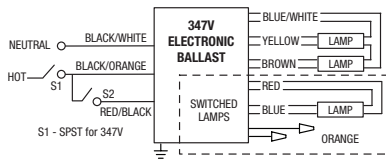

Switching: Simultaneously disconnect all ungrounded line conductors

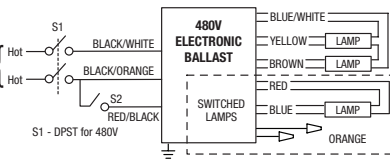

Operates 3 or 1 Lamps

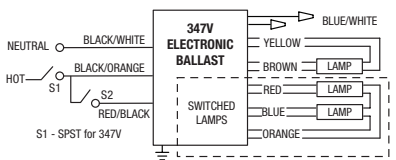

Switching: Simultaneously disconnect all ungrounded line conductors

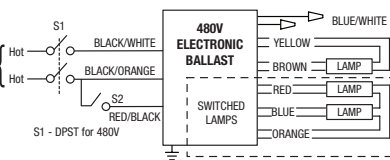

**2-Lamp Switching Wiring Diagram (2L to 1L)**

S1	S2	2/1
ON	ON	2
ON	OFF	1

Operates 2 or 1 Lamps

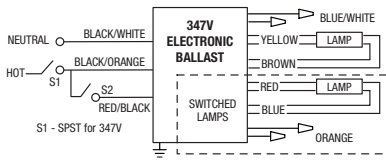

Switching: Simultaneously disconnect all ungrounded line conductors

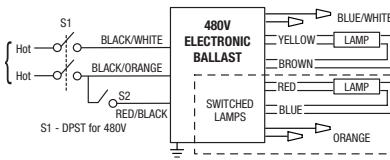

**Installation Notes**

- Install in accordance with National & Local Electric Code
- Ground ballast case
- Switching: Simultaneously disconnect all ungrounded line conductors
- For 480V applications connect two phases (line and line) to the input
- For 347V applications connect line and neutral to the input as shown (DO NOT CONNECT two phases of 347V to the same ballast)
- Insulate unused leads for 600V

Input wiring for occupancy sensor  
Bi-level control  
(S2 is the occupancy sensor)

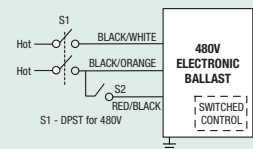
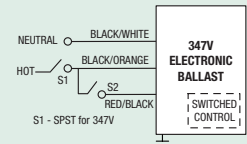

Products distributed by  
LEDVANCE LLC

For Customer Service contact  
1-800 LIGHTBULB

Specifications subject to change without notice.

**SPECIFICATION DATA**

Catalog #	Date	Type
Project	Prepared by	
Comments		

**High Efficiency Type CC & Universal Voltage (120-277V)**



Item Number	Description	Input Current (AMPS)	Lamp <sup>1</sup> Type	Rated <sup>1</sup> Lumens (lm)	No. of Lamps	Ballast <sup>1</sup> Factor (BF)	System <sup>1</sup> Lumens	Mean <sup>1</sup> Lumens	Input <sup>1</sup> Power (Watts)		System <sup>2</sup> Efficacy (lm/W)	BEF <sup>2</sup>
									347V	480V		
<b>QHE 2x54T5HO Fixed Output</b>												
51486 Ⓞ 20-pack (without leads) 51485 Ⓞ 10-pack (with leads)	QHE2x54T5HO/347-480 PSN-HT	0.35/0.25	FP54T5HO	5000	2	1.00	10,000	9300	118	117	85	0.85
		0.30/0.23	FP54/50W/SS	5000	2	1.00	10,000	9300	109	108	93	0.93
		<b>0.30/0.22</b>	<b>FP54/47W/SS</b>	<b>4575</b>	<b>2</b>	<b>1.02</b>	<b>9335</b>	<b>8680</b>	<b>104</b>	<b>102</b>	<b>92</b>	<b>1.00</b>
		0.32/0.23	FT55DL	4800	2	0.86	8255	7680	104	103	80	0.83
		0.33/0.24	FT50DL	4300	2	1.00	8600	8000	109	108	80	0.93
		0.31/0.22	L58	5200	2	1.00	10,400	9670	108	107	97	0.93
		0.26/0.22	FPC55	4000	2	0.75	6000	5040	91	90	67	0.83
		0.18/0.14	FP54T5HO	5000	1	1.00	5000	4650	60	59	85	1.69
		0.16/0.11	FP54/50W/SS	5000	1	1.01	5050	4695	56	55	92	1.84
		<b>0.15/0.11</b>	<b>FP54/47W/SS</b>	<b>4575</b>	<b>1</b>	<b>0.98</b>	<b>4484</b>	<b>4170</b>	<b>52</b>	<b>51</b>	<b>88</b>	<b>1.92</b>
		0.17/0.13	FT55DL	4800	1	0.87	4175	3885	55	54	77	1.61
		0.18/0.14	FT50DL	4300	1	1.02	4385	4080	57	56	78	1.82
		0.17/0.12	L58	5200	1	0.87	4525	4205	56	55	82	1.58
		0.14/0.11	FPC55	4000	1	0.77	3080	2585	48	47	66	1.64

Item Number	Description	Input Current (AMPS)	Lamp <sup>1</sup> Type	Rated <sup>1</sup> Lumens (lm)	No. of Lamps	Ballast <sup>1</sup> Factor (BF)	System <sup>1</sup> Lumens	Mean <sup>1</sup> Lumens	Input <sup>1</sup> Power (Watts)		System <sup>2</sup> Efficacy (lm/W)	BEF <sup>2</sup>
									347V	480V		
<b>QHE 4x54T5HO Switchable Model</b>												
51481 Ⓞ 10-pack (with leads)	QHE4x54T5HO/347-480 PSN-HT-SCL	0.67/0.48	FP54T5HO	5000	4	1.00	20,000	18,600	232	228	88	0.44
		0.63/0.45	FP54/50W/SS	5000	4	1.02	20,400	18,970	212	207	99	0.49
		<b>0.59/0.43</b>	<b>FP54/47W/SS</b>	<b>4575</b>	<b>4</b>	<b>1.02</b>	<b>18,665</b>	<b>17,360</b>	<b>205</b>	<b>203</b>	<b>92</b>	<b>0.50</b>
		0.63/0.46	FT55DL	4800	4	0.91	17,470	16,250	217	215	81	0.42
		0.66/0.48	FT50DL	4300	4	1.02	17,545	16,315	225	222	79	0.46
		0.62/0.45	L58	5200	4	0.97	20,175	18,765	214	213	95	0.46
		0.51/0.37	FPC55	4000	4	0.88	14,080	13,095	181	175	80	0.50
		0.51/0.37	FP54T5HO	5000	3	1.03	15,450	14,370	178	177	87	0.58
		0.48/0.35	FP54/50W/SS	5000	3	1.02	15,300	14,230	165	164	93	0.62
		<b>0.45/0.33</b>	<b>FP54/47W/SS</b>	<b>4575</b>	<b>3</b>	<b>1.04</b>	<b>14,275</b>	<b>13,275</b>	<b>156</b>	<b>155</b>	<b>92</b>	<b>0.67</b>
		0.48/0.35	FT55DL	4800	3	0.92	13,250	12,320	165	163	81	0.56
		0.49/0.36	FT50DL	4300	3	1.03	13,285	12,355	170	167	80	0.62
		0.47/0.34	L58	5200	3	0.97	15,130	14,075	162	162	93	0.60
		0.41/0.30	FPC55	4000	3	0.92	11,040	10,265	144	141	78	0.65
		0.33/0.24	FP54T5HO	5000	2	1.03	10,300	9580	118	116	89	0.89
		0.32/0.24	FP54/50W/SS	5000	2	1.02	10,200	9485	108	106	96	0.96
		<b>0.30/0.23</b>	<b>FP54/47W/SS</b>	<b>4575</b>	<b>2</b>	<b>1.03</b>	<b>9425</b>	<b>8765</b>	<b>103</b>	<b>101</b>	<b>93</b>	<b>1.02</b>
		0.31/0.24	FT55DL	4800	2	0.93	8930	8305	107	106	84	0.88
		0.33/0.24	FT50DL	4300	2	1.04	8945	8320	112	109	82	0.95
		0.31/0.23	L58	5200	2	0.97	10,090	9380	106	106	95	0.92
		0.27/0.20	FPC55	4000	2	0.90	7200	6695	91	89	81	1.01
		0.17/0.13	FP54T5HO	5000	1	1.05	5250	4885	59	58	91	1.81
		0.17/0.13	FP54/50W/SS	5000	1	1.03	5150	4790	56	55	94	1.87
		<b>0.16/0.13</b>	<b>FP54/47W/SS</b>	<b>4575</b>	<b>1</b>	<b>1.04</b>	<b>4760</b>	<b>4425</b>	<b>53</b>	<b>53</b>	<b>90</b>	<b>1.96</b>
		0.17/0.13	FT55DL	4800	1	0.90	4320	4020	56	55	79	1.64
		0.17/0.14	FT50DL	4300	1	1.04	4470	4160	57	57	78	1.82
		0.17/0.13	L58	5200	1	0.98	5095	4740	58	57	89	1.72
		0.14/0.12	FPC55	4000	1	0.95	3800	3535	55	53	72	1.79

1 At 35°C lamp ambient temperature.  
 2 Ballast Efficiency Factor (BEF) shown = (Ballast Factor x 100) divided by Input Power (Note: calculation based on lowest wattage value).  
 3 System Efficacy calculation based on lowest input power value.  
 Ⓞ Preliminary specifications. Please contact OSRAM SYLVANIA for additional information.

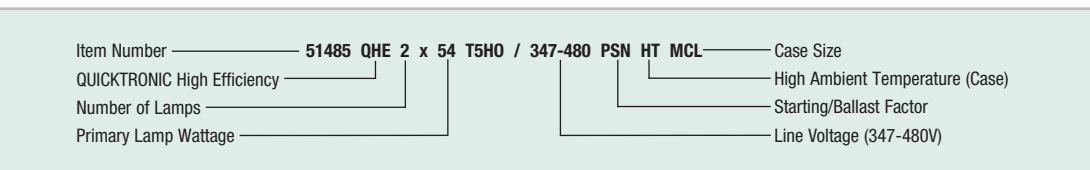

**Normal Ballast Factor**

**T5HO PROStart®**

**High Efficiency**

**Performance Guide**

Data based upon PENTRON® HO lamps shown. QUICKTRONIC® 347-480V T5HO HT ballasts are also compatible with other lamp manufacturers equivalent lamp types that meet ANSI specifications.

**Specifications<sup>4</sup>**

- Starting Method: Programmed Rapid Start
- Ballast Factor: 1.00 (see table)
- Circuit Type: Series
- Lamp Frequency: >42kHz
- Lamp CCF: Less than 1.6
- Starting Temp: -20°F (-29°C)<sup>5</sup>
- Input Frequency: 50/60Hz
- Low THD: <10%
- Power Factor: >98%
- Voltage Range: ±10% of Rated Input
- UL Listed Class P, Type 1, Outdoor, UL Type CC Rated
- CSA Certified
- High Ambient Applications: 90°C Max. Case Temp. (3 yr. warranty)
- Standard Ambient Applications: 70°C Max. Case Temp. (5 yr. warranty)
- FCC 47CFR Part 18 Non-Consumer Class A Sound Rating
- RoHS Compliant<sup>6</sup>
- ANSI C62.41 Cat. A Transient Protection
- QUICKSENSE® Dynamic End-of-Lamp-Life Sensing
- Remote Mounting (Max. wire length from ballast case to lampholder): up to 18 feet. Remote red leads up to 18 feet. Keep blue leads <10 feet.

**System Life / Warranty**

QUICKTRONIC products are covered by the QUICK 60+® warranty, a comprehensive lamp and ballast system warranty. For additional details, refer to the QUICK 60+ warranty bulletin.

Products distributed by LEDVANCE LLC

For Customer Service contact 1-800 LIGHTBULB

Specifications subject to change without notice.

QHE T5HO 347-480V HT

